

KSK 400 4D



Centrifugal kitchen fan in sound-insulated casing

- Maximum airflow: 5098
- Sound pressure level LpA at 3 m: 53
- Fire resistance class: 120°C within 60 min
- Sound insulation
- Motor type: AC
- Impeller type: Centrifugal backward curved blades
- Casing material: Galvanized steel

	Unit of measurement	KSK 400 4D
Connected air duct size	mm	400
Speed	-	1
Minimum supply voltage	V	400
Maximum supply voltage	V	400
Power supply frequency	Hz	50
Rated power	W	785
Unit current	A	2.25
Maximum airflow	m ³ /h	5098
Sound pressure level LpA at 3 m	dB(A)	53
Weight	kg	92
Transported air temperature (max)	°C	110
Transported air temperature (min)	°C	-20
Ingress protection rating	-	IP54

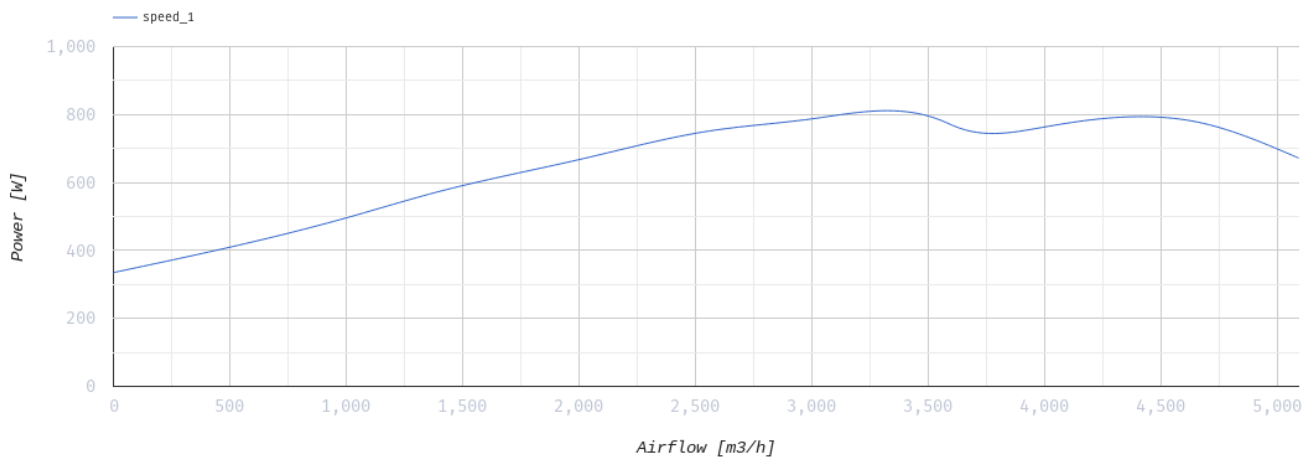
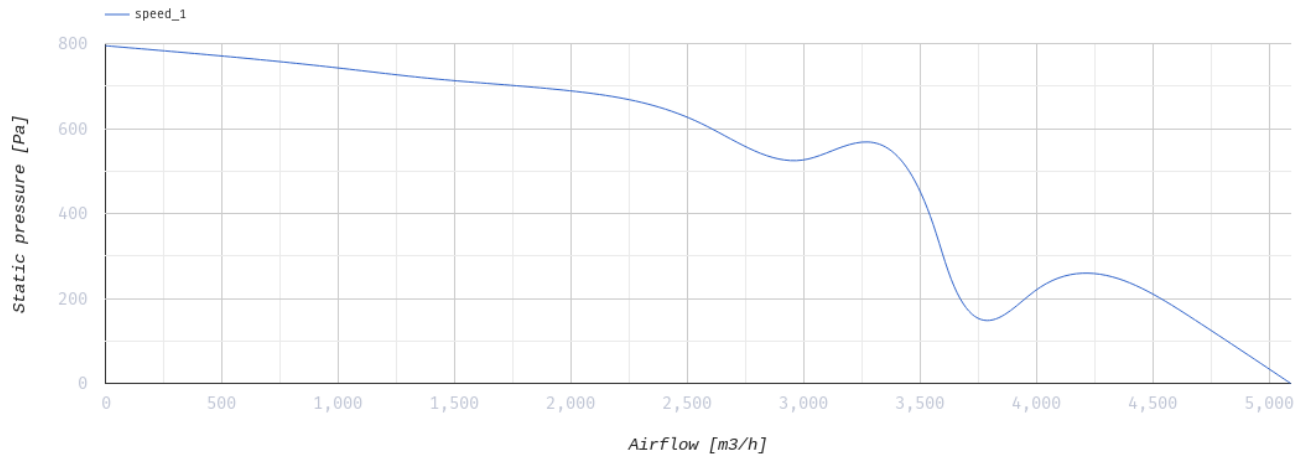

Dimensions

ØD	B	B1	H	H1	L	L1	L2	L3	L4
400	906	700	900	790	908	900	850	747	402

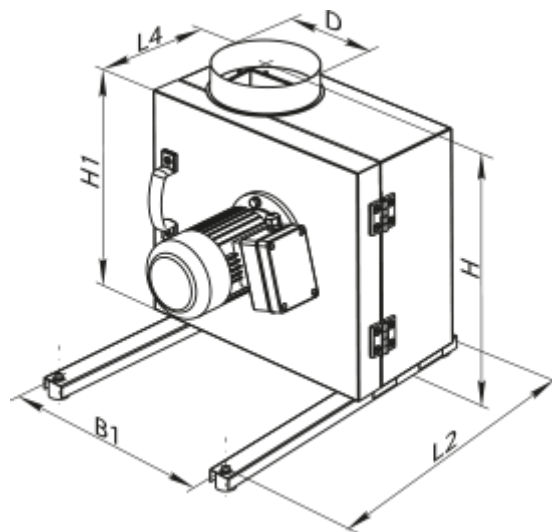



Accessories

Other accessories

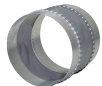
Name	Photo	Description
VVG 400		Flexible anti-vibration connector