

# KSK 450 6D



Centrifugal kitchen fan in sound-insulated casing

- Maximum airflow: 4991
- Sound pressure level LpA at 3 m: 49
- Fire resistance class: 120°C within 60 min
- Sound insulation
- Motor type: AC
- Impeller type: Centrifugal backward curved blades
- Casing material: Galvanized steel

	Unit of measurement	KSK 450 6D
Connected air duct size	mm	450
Speed	-	1
Minimum supply voltage	V	400
Maximum supply voltage	V	400
Power supply frequency	Hz	50
Rated power	W	454
Unit current	A	1.33
Maximum airflow	m <sup>3</sup> /h	4991
Sound pressure level LpA at 3 m	dB(A)	49
Weight	kg	105
Transported air temperature (max)	°C	110
Transported air temperature (min)	°C	-20
Ingress protection rating	-	IP54

## Dimensions

ØD	B	B1	H	H1	L	L1	L2	L3	L4
450	996	750	980	870	925	900	850	739	437

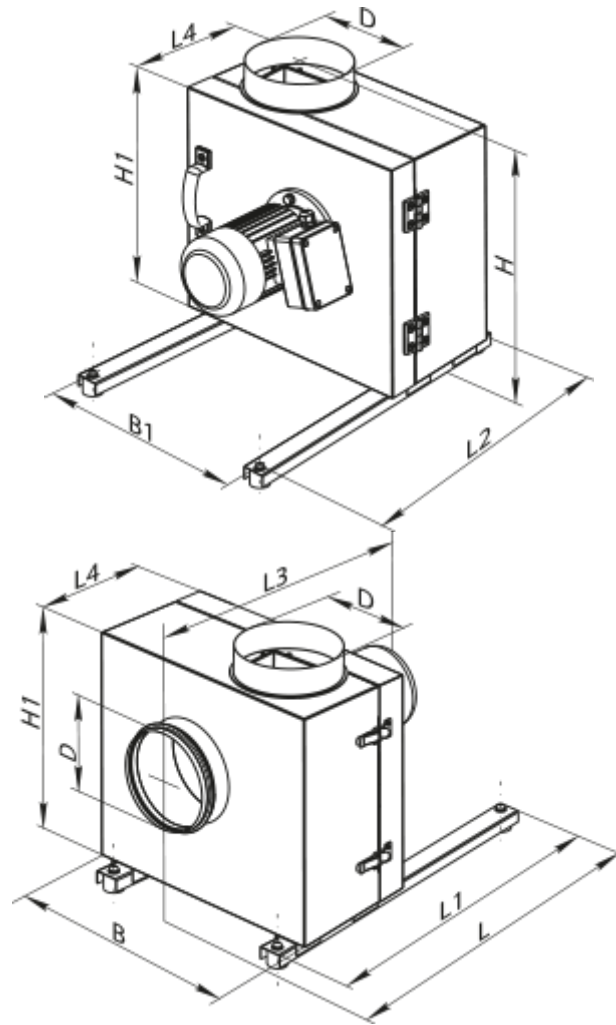

## Accessories

### Other accessories

Name	Photo	Description
<a href="#">VVG 450</a>		Flexible anti-vibration connector