

Micra 110 V1

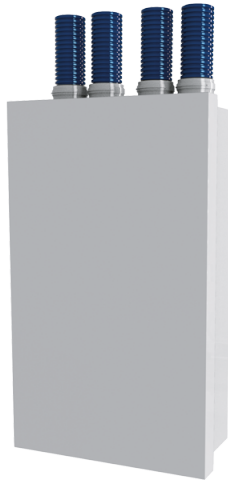

Decentralized supply and exhaust unit with heat recovery. Air flow: up to 100 m³/h

- Maximum airflow: 100
- Sound pressure level LpA at 3 m: 31
- Sound pressure level LpA at 1 m: 40
- Heat recovery efficiency: 93
- Heat exchanger type: Counter flow
- Extract filter: G4
- Supply filter: G4 опция: F7, G4 option: F7
- Sound insulation
- Motor type: EC
- Control: Built-in control panel
- Casing material: Galvanized steel
- Humidity sensor: Built-in
- Temperature sensor: Built-in

	Unit of measurement	Micra 110 V1		
Connected air duct size	mm	100		
Speed	-	3		
Minimum supply voltage	V	230		
Maximum supply voltage	V	230		
Power supply frequency	Hz	50/60		
Rated power	W	10	15	31
Unit current	A	0.26		
Maximum airflow	m ³ /h	30	60	100
Sound pressure level LpA at 3 m	dB(A)	10	21	31
Sound pressure level LpA at 1 m	dB(A)	20	30	40
Heat recovery efficiency	%	93	87	84
Heat exchanger type	-	Counter flow		
Heat exchanger material	-	Polystyrene		
Weight	kg	23		
Extract filter	-	G4		
Supply filter	-	G4 опция: F7, G4 option: F7		
Transported air temperature (max)	°C	40		
Transported air temperature (min)	°C	-15		
Ambient air temperature min	°C	1		
Ambient air temperature max	°C	40		
Ambient air humidity max	%	60		

Ingress protection rating	-	IP20
Ingress protection rating of the drive	-	IP44

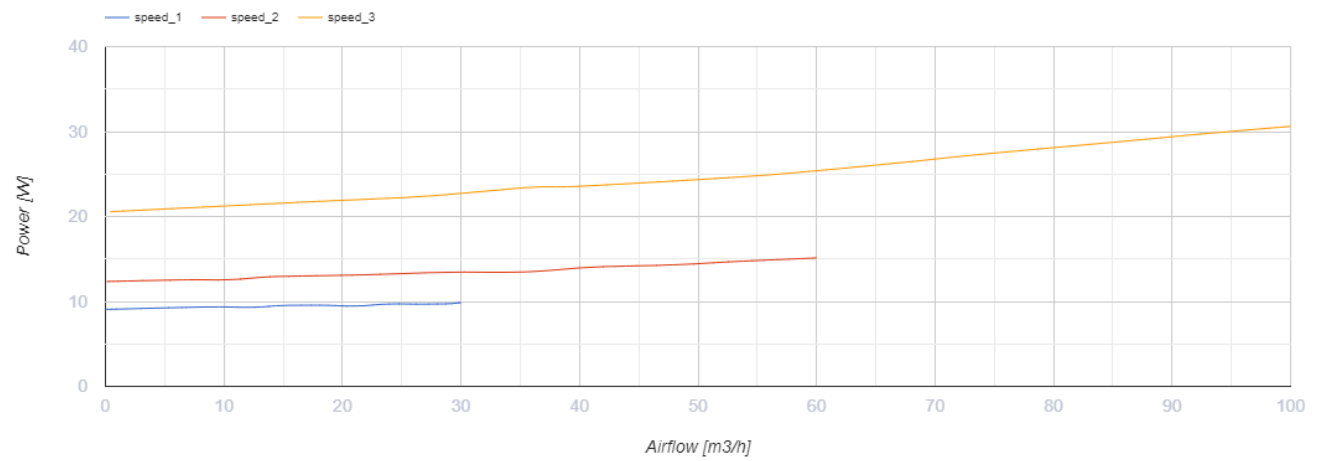
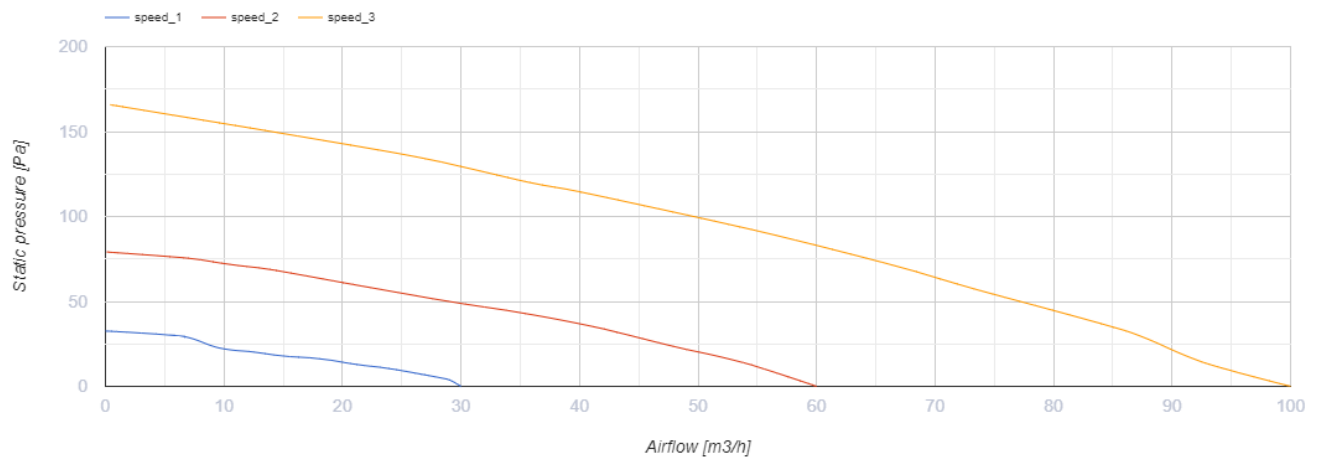



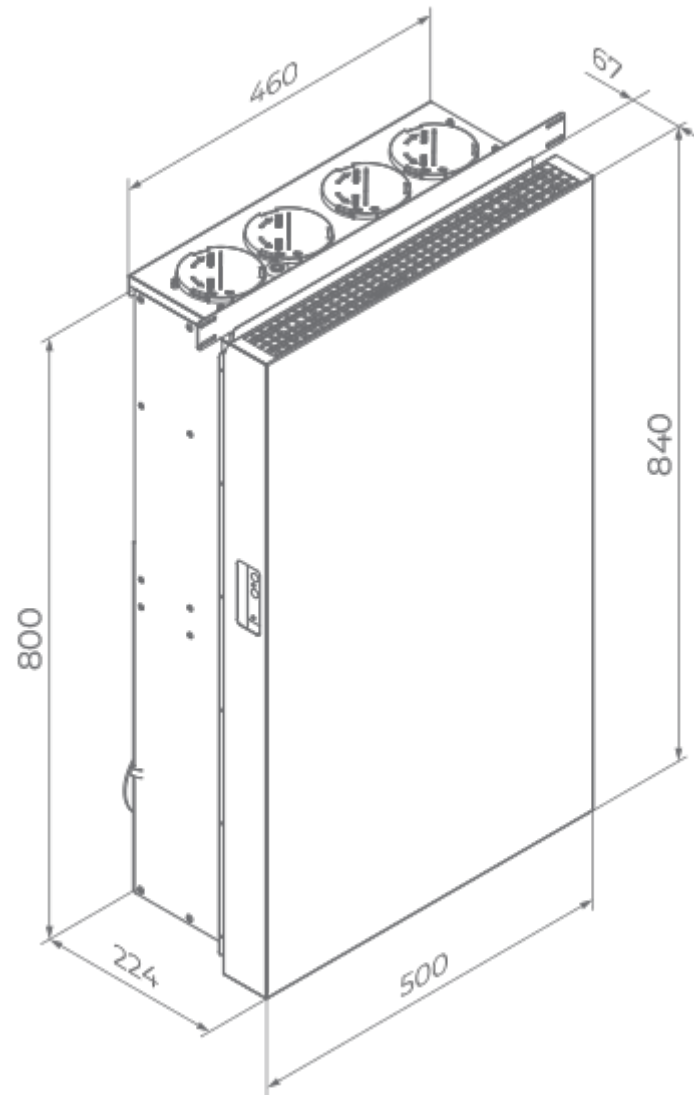









Dimensions







Accessories

Other accessories

Name	Photo	Description
SF 176x160x22 G4		Panel filter G4
SF 203x150x22 G4		Panel filter G4
SF 203x150x22 F7		F7 panel filter
MK Micra 110		Mounting kit: Two plastic air ducts; Outdoor box; Cardboard template

MK Micra 110 chrome		Mounting kit: Two plastic air ducts; Outdoor box; Cardboard template
MK Micra 110 white		Mounting kit: Two plastic air ducts; Outdoor box; Cardboard template
MK1 Micra 110		Mounting kit for corner mounting of the grille in the window opening
MK1 Micra 110 chrome		Mounting kit for corner mounting of the grille in the window opening
MK1 Micra 110 white		Mounting kit for corner mounting of the grille in the window opening
NB Micra 110		Outdoor box
NB Micra 110 chrome		Outdoor box
NB Micra 110 white		Outdoor box
NE Micra 100		Heater to prevent condensate freezing in the drain pipe and the outdoor box

Sensors

Name	Photo	Description
CO2-1		CO2 sensors
CO2-2		CO2 sensors
CO2-3		CO2 sensor
HR-S		Electro-mechanical humidistats

System 75

Name	Photo	Description
------	-------	-------------

[FlexiVent 0275](#)



For connection of the air ducts to the connectors and air distribution boxes

Ecodesign

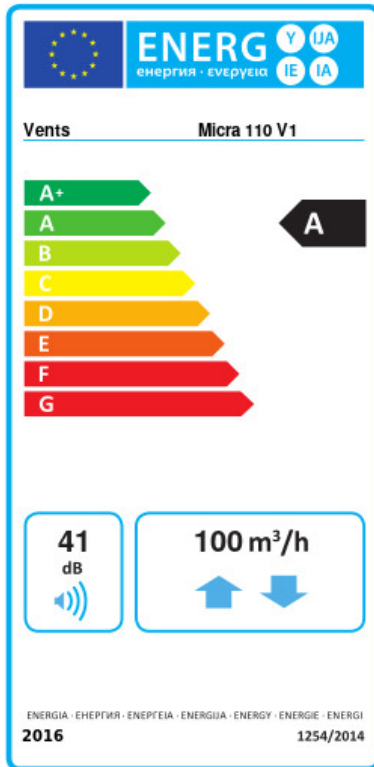

Trademark	Vents					
Model	Micra 110 V1					
Specific energy consumption (SEC) (kWh/(m ² /a))	Cold		Average		Warm	
	79.7	A+	41	A	16.3	E
Type of ventilation unit	Bidirectional					
Type of drive installed	3-speed					
Type of heat recovery system	Recuperative					
Thermal efficiency of heat recovery (%)	87					
Maximum flow rate (m ³ /h)	100					
Electric power input (W)	30.6					
Reference flow rate (m ³ /s)	0.017					
Specific power input (SPI) (W/(m ³ /h))	0.252					
Control typology	Local demand control					
Maximum internal leakage rates (%)	1.7					
Maximum external leakage rates (%)	4.7					
Mixing rate (%)	1					
Airflow sensitivity at +20 Pa and -20 Pa (%)	0					
Declared typology	RVU BVU					
Sound power level (dB(A))	41					
The annual electricity consumption (AEC) (kWh/a)	Cold		Average		Warm	
	764		227		182	
The annual heating saved (AHS) (kWh/a)	Cold		Average		Warm	
	9007		4604		2082	