

# MV 100 FB

Ventilation grille with a mosquito screen for decorative panels

- Casing material: Plastic

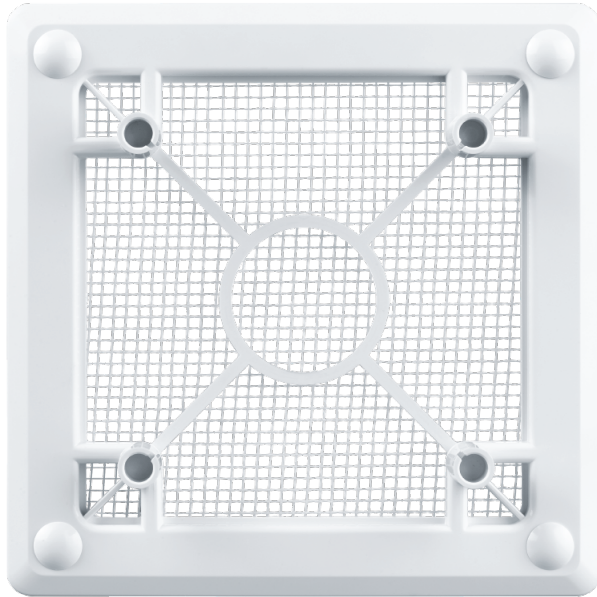

	Unit of measurement	MV 100 FB
--	---------------------	-----------

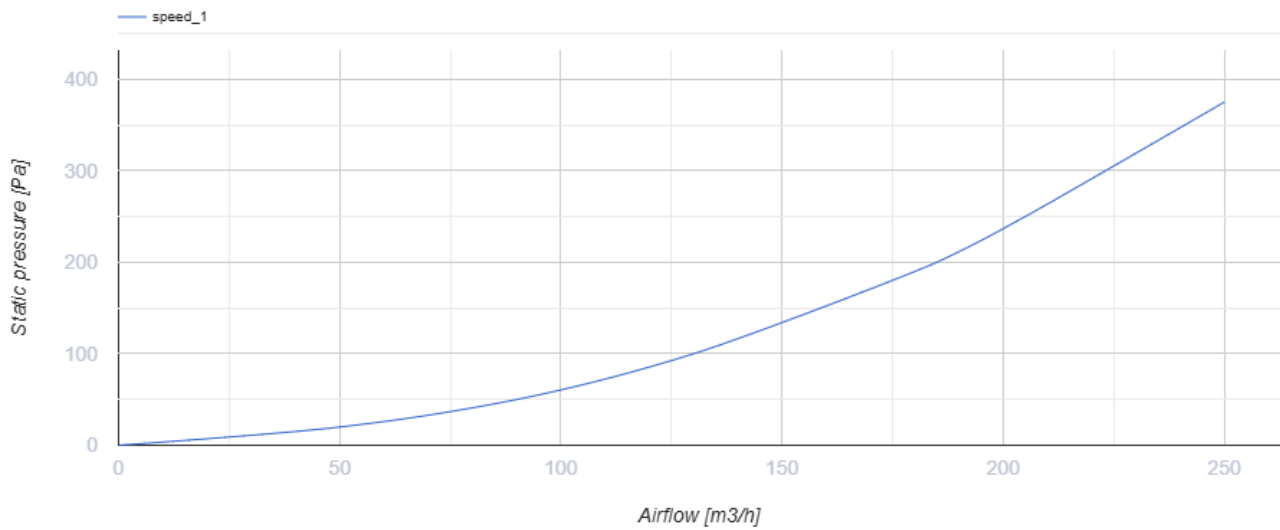



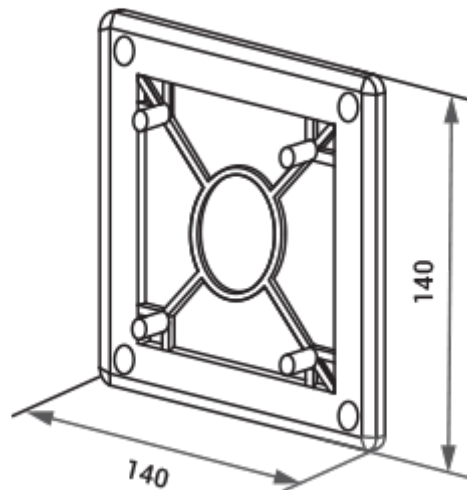



















## Dimensions



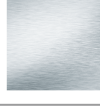
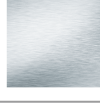

## Accessories

### Decorative panels

Name	Photo	Description
<a href="#">FP_180 Plain</a>		Removable decorative front panels are a universal solution allowing to choose the design of a fan or ventilation grille for any interior of a bathroom or kitchen.
<a href="#">FP_160 Plain</a>		Removable decorative front panels are a universal solution allowing to choose the design of a fan or ventilation grille for any interior of a bathroom or kitchen.
<a href="#">FP_180 Plain red</a>		Removable decorative front panels are a universal solution allowing to choose the design of a fan or ventilation grille for any interior of a bathroom or kitchen.
<a href="#">FP_160 Plain red</a>		Removable decorative front panels are a universal solution allowing to choose the design of a fan or ventilation grille for any interior of a bathroom or kitchen.
<a href="#">FP_180 Plain black sapphire</a>		Removable decorative front panels are a universal solution allowing to choose the design of a fan or ventilation grille for any interior of a bathroom or kitchen.
<a href="#">FP_160 Plain black sapphire</a>		Removable decorative front panels are a universal solution allowing to choose the design of a fan or ventilation grille for any interior of a bathroom or kitchen.
<a href="#">FP_180 Plain metallic</a>		Removable decorative front panels are a universal solution allowing to choose the design of a fan or ventilation grille for any interior of a bathroom or kitchen.
<a href="#">FP_180 Plain wing</a>		Removable decorative front panels are a universal solution allowing to choose the design of a fan or ventilation grille for any interior of a bathroom or kitchen.
<a href="#">FPB_180/100 Disc</a>		Removable decorative front panels are a universal solution allowing to choose the design of a fan or ventilation grille for any interior of a bathroom or kitchen.

<a href="#">FP 180 Aqua</a>		Removable decorative front panels are a universal solution allowing to choose the design of a fan or ventilation grille for any interior of a bathroom or kitchen.
<a href="#">FP 180 Mars</a>		Removable decorative front panels are a universal solution allowing to choose the design of a fan or ventilation grille for any interior of a bathroom or kitchen.
<a href="#">FP 180 Mystery</a>		Removable decorative front panels are a universal solution allowing to choose the design of a fan or ventilation grille for any interior of a bathroom or kitchen.
<a href="#">FP 160 Reef</a>		Removable decorative front panels are a universal solution allowing to choose the design of a fan or ventilation grille for any interior of a bathroom or kitchen.
<a href="#">FP 160 Frizz</a>		Removable decorative front panels are a universal solution allowing to choose the design of a fan or ventilation grille for any interior of a bathroom or kitchen.
<a href="#">FP 180 Plain chrome</a>		Removable decorative front panels are a universal solution allowing to choose the design of a fan or ventilation grille for any interior of a bathroom or kitchen.
<a href="#">FP 160 Plain chrome</a>		Removable decorative front panels are a universal solution allowing to choose the design of a fan or ventilation grille for any interior of a bathroom or kitchen.
<a href="#">FP 180 Plain alumat</a>		Removable decorative front panels are a universal solution allowing to choose the design of a fan or ventilation grille for any interior of a bathroom or kitchen.
<a href="#">FP 160 Plain alumat</a>		Removable decorative front panels are a universal solution allowing to choose the design of a fan or ventilation grille for any interior of a bathroom or kitchen.
<a href="#">FPB 160 Glass-1</a>		Removable decorative front panels are a universal solution allowing to choose the design of a fan or ventilation grille for any interior of a bathroom or kitchen.
<a href="#">FPB 180/100 Glass-1</a>		Removable decorative front panels are a universal solution allowing to choose the design of a fan or ventilation grille for any interior of a bathroom or kitchen.
<a href="#">FPB 160 Glass-1 red</a>		Removable decorative front panels are a universal solution allowing to choose the design of a fan or ventilation grille for any interior of a bathroom or kitchen.
<a href="#">FPB 180/100 Glass-1 red</a>		Removable decorative front panels are a universal solution allowing to choose the design of a fan or ventilation grille for any interior of a bathroom or kitchen.
<a href="#">FPB 160 Glass-1 black</a>		Removable decorative front panels are a universal solution allowing to choose the design of a fan or ventilation grille for any interior of a bathroom or kitchen.
<a href="#">FPB 180/100 Glass-1 black</a>		Removable decorative front panels are a universal solution allowing to choose the design of a fan or ventilation grille for any interior of a bathroom or kitchen.

<a href="#">FP 180 Plain gold</a>		Removable decorative front panels are a universal solution allowing to choose the design of a fan or ventilation grille for any interior of a bathroom or kitchen.
<a href="#">FP 180 Plain dim</a>		Removable decorative front panels are a universal solution allowing to choose the design of a fan or ventilation grille for any interior of a bathroom or kitchen.