

Stream 100/125 EC P

Mixed-flow inline fans in sound-insulated casings with EC-motors

- Maximum airflow: 350
- Sound pressure level LpA at 3 m: 28
- Sound insulation
- Motor type: EC
- Control: Built-in speed controller
- Impeller type: Mixed-flow
- Casing material: Plastic



	Unit of measurement	Stream 100/125 EC P
Connected air duct size	mm	125
Speed	-	1
Phases	-	1
Minimum supply voltage	V	230
Maximum supply voltage	V	230
Power supply frequency	Hz	50/60
Rated power	W	20
Unit current	A	0.77
Maximum airflow	m ³ /h	350
rotation speed at 50hz	-	3002
Sound pressure level LpA at 3 m	dB(A)	28
Weight	kg	3.6
Transported air temperature (max)	°C	55
Transported air temperature (min)	°C	-25
Ambient air temperature min	°C	1
Ambient air temperature max	°C	40
Ingress protection rating	-	IPX4
Ingress protection rating of the drive	-	IP44

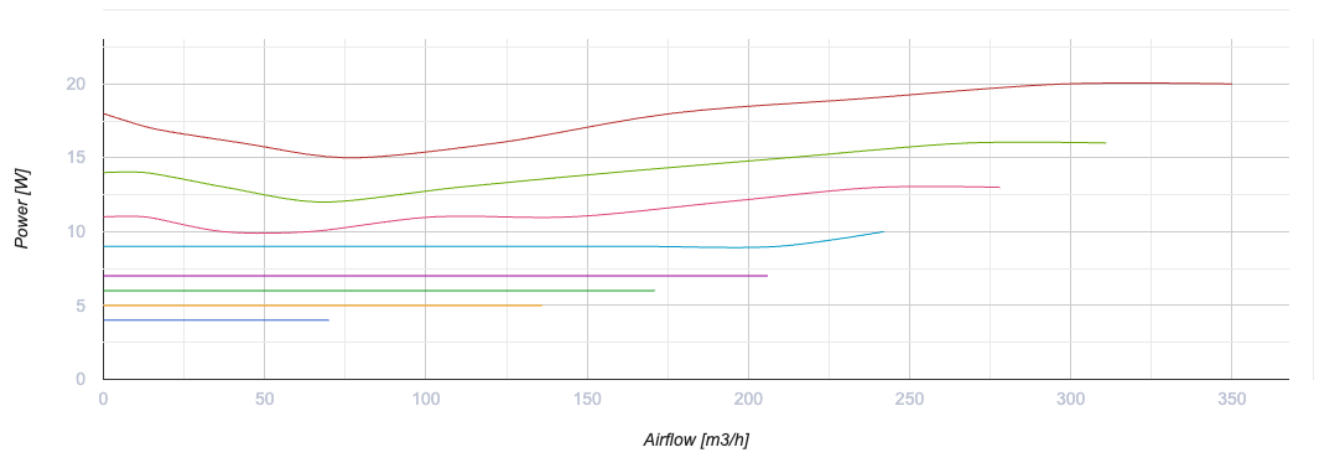
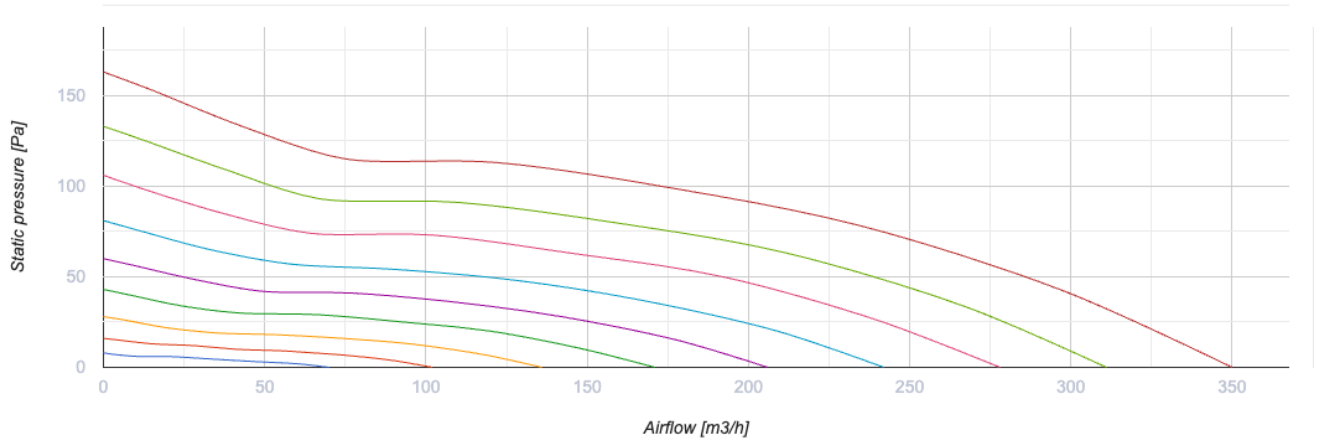

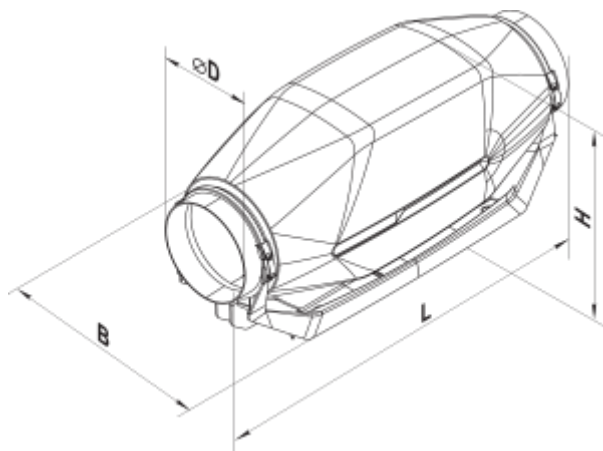

Dimensions

$\varnothing D$	B	L	H
125	207	502	224







Accessories



For round ducts

Name	Photo	Description
SR 125/600		Silencers made of galvanized steel filled with non-combustible sound-absorbing material
SR 125/900		Silencers made of galvanized steel filled with non-combustible sound-absorbing material
SR 125/1200		Silencers made of galvanized steel filled with non-combustible sound-absorbing material

For round ducts



Name	Photo	Description
FB 125		Round panel air filters
FBK 125-4		Round bag air filters
FBK 125-5		Round bag air filters
FBK 125-7		Round bag air filters

Electrical heaters



Name	Photo	Description
NK 125-0,6-1		Round electric inline heaters with round cross-section
NK 125-0,8-1		Round electric inline heaters with round cross-section
NK 125-1,2-1		Round electric inline heaters with round cross-section
NK 125-1,6-1		Round electric inline heaters with round cross-section

NK 125-2,4-1		Round electric inline heaters with round cross-section
------------------------------	---	--

Water heaters

Name	Photo	Description
NKV 125-2		Inline water supply air heaters or heater for air handling units with a round cross-section
NKV 125-4		Inline water supply air heaters or heater for air handling units with a round cross-section

For round ducts

Name	Photo	Description
KOM 125		Backdraught damper with spring-loaded plates for shutting off air flow in round air ducts
KR 125		Air dampers for controlling air flow in round air ducts

Speed controllers

Name	Photo	Description
R-1/010		Speed controller for EC motors