

Stream 100/125 EC S (100 spigot) R

Sound- and heat-insulated mixed flow duct fans with EC motor

- Maximum airflow: 295
- Sound pressure level LpA at 3 m: 31
- Sound insulation
- Motor type: EC
- Impeller type: Mixed
- Casing material: Plastic
- Installation in any position
- Cable with mains plug



	Unit of measurement	Stream 100/125 EC S (100 spigot) R
Connected air duct size	mm	100
Speed	-	1
Phases	-	1
Minimum supply voltage	V	230
Maximum supply voltage	V	230
Power supply frequency	Hz	50/60
Rated power	W	39
Unit current	A	0.36
Maximum airflow	m ³ /h	295
rotation speed at 50hz	-	3168
Sound pressure level LpA at 3 m	dB(A)	31
Weight	kg	5
Transported air temperature (max)	°C	55
Transported air temperature (min)	°C	-25
Ingress protection rating	-	IPX4
Ingress protection rating of the drive	-	IP44
ErP compliance	-	2016, 2018
Cold - Specific energy consumption (SEC)	kWh/(m ² /a)	54.3
SEC Class Cold	-	A+





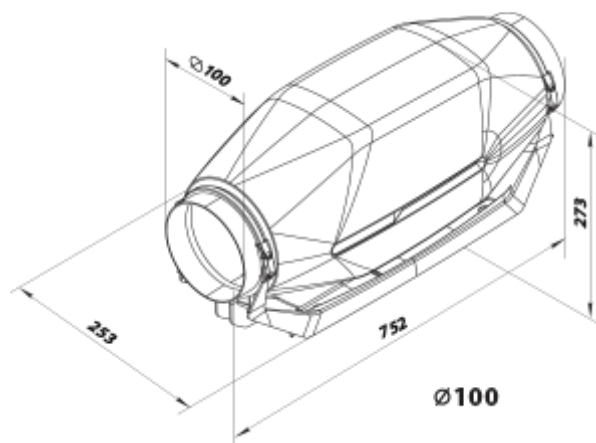





Average - Specific energy consumption (SEC)	kWh/(m ² /a)	27.3
SEC Class Average	-	B
Warm - Specific energy consumption (SEC)	kWh/(m ² /a)	11.8
SEC Class Warm	-	E
Unit category	-	RVU
Type of ventilation unit	-	Unidirectional
Type of drive installed	-	Variable speed
Type of heat recovery system	-	None
Maximum flow rate	m ³ /h	320
Electric power input	W	39
Reference flow rate	m ³ /s	0.054
Reference pressure difference	Pa	50
Specific power input (SPI)	W/(m ³ /h)	0.077
Control typology	-	Local demand control
Maximum external leakage rates	%	2.7
Cold - The annual electricity consumption (AEC)	kWh/a	41
Average - The annual electricity consumption (AEC)	kWh/a	41
Warm - Jährlicher Stromverbrauch (JSV)	kWh/a	41
Cold - The annual heating saved (AHS)	kWh/a	5536
The annual heating saved (AHS) Average	kWh/a	2830
The annual heating saved (AHS) Warm	kWh/a	1280
Sound power level	dB(A)	54
Declared typology	-	RVU UVU

Dimensions





Accessories

Electrical heaters



Name	Photo	Description
NK 100-0,8-1 U		Duct electric heater with temperature controller or control unit
NK 100-0,6-1 U		Duct electric heater with temperature controller or control unit
NK 100-1,8-1		Duct electric heater
NK 100-1,6-1		Duct electric heater
NK 100-1,2-1		Duct electric heater
NK 100-0,8-1		Duct electric heater
NK 100-0,6-1		Duct electric heater
NK 100-1,2-1 U		Duct electric heater with temperature controller or control unit
NK 100-1,6-1 U		Duct electric heater with temperature controller or control unit
NK 100-1,8-1 U		Duct electric heater with temperature controller or control unit

For round ducts



Name	Photo	Description
FB 100		Panel filters
FBK 100-4		Pocket filter
FBK 100-5		Pocket filter

FBK 100-7		Pocket filter
---------------------------	---	---------------

For round ducts

Name	Photo	Description
SR 100/1200		Silencer is applied for noise absorption produced during the ventilating equipment operation and spread along the ducting systems
SR 100/900		Silencer is applied for noise absorption produced during the ventilating equipment operation and spread along the ducting systems
SR 100/600		Silencer is applied for noise absorption produced during the ventilating equipment operation and spread along the ducting systems



For round ducts

Name	Photo	Description
KOM 100		Spring-loaded backdraft damper for round ducts
KOMu 100		Spring-loaded backdraft damper for round ducts
KR 100		Air damper for air flow control in round air ducts

Speed controllers

Name	Photo	Description
R-1/010		Speed controller for EC motors

Water heaters

Name	Photo	Description
NKV 100-2		Duct water heaters are designed for heating of supply air in round ventilation systems. They can be also applied in supply or supply and exhaust ventilating units
NKV 100-4		Duct water heaters are designed for heating of supply air in round ventilation systems. They can be also applied in supply or supply and exhaust ventilating units