

Stream 150/160 P



Mixed-flow inline fans in sound-insulated casings

- Maximum airflow: 540
- Sound pressure level LpA at 3 m: 33
- Sound insulation
- Motor type: AC
- Control: Built-in speed controller
- Impeller type: Mixed-flow
- Casing material: Plastic

	Unit of measurement	Stream 150/160 P		
Connected air duct size	mm	160/150		
Speed	-	3		
Phases	-	1		
Minimum supply voltage	V	230		
Maximum supply voltage	V	230		
Power supply frequency	Hz	50		
Rated power	W	25	46	51
Unit current	A	0.2	0.21	0.24
Maximum airflow	m ³ /h	242	320	540
rotation speed at 50hz	-	1982	2374	2738
Sound pressure level LpA at 3 m	dB(A)	20	26	33
Weight	kg	5		
Transported air temperature (max)	°C	55		
Transported air temperature (min)	°C	-25		
Ambient air temperature min	°C	1		
Ambient air temperature max	°C	40		
Ingress protection rating	-	IPX4		
Ingress protection rating of the drive	-	IP20		

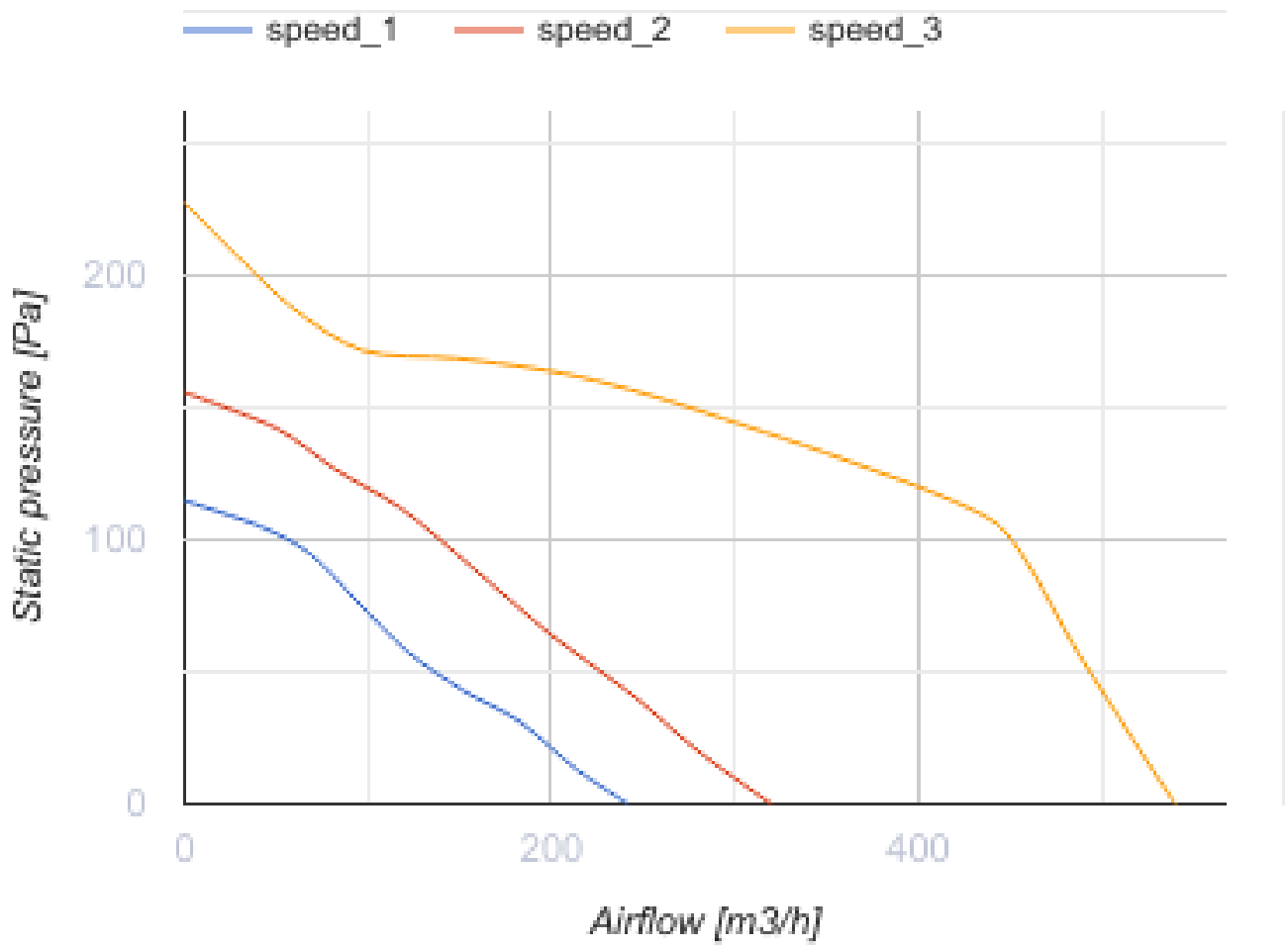

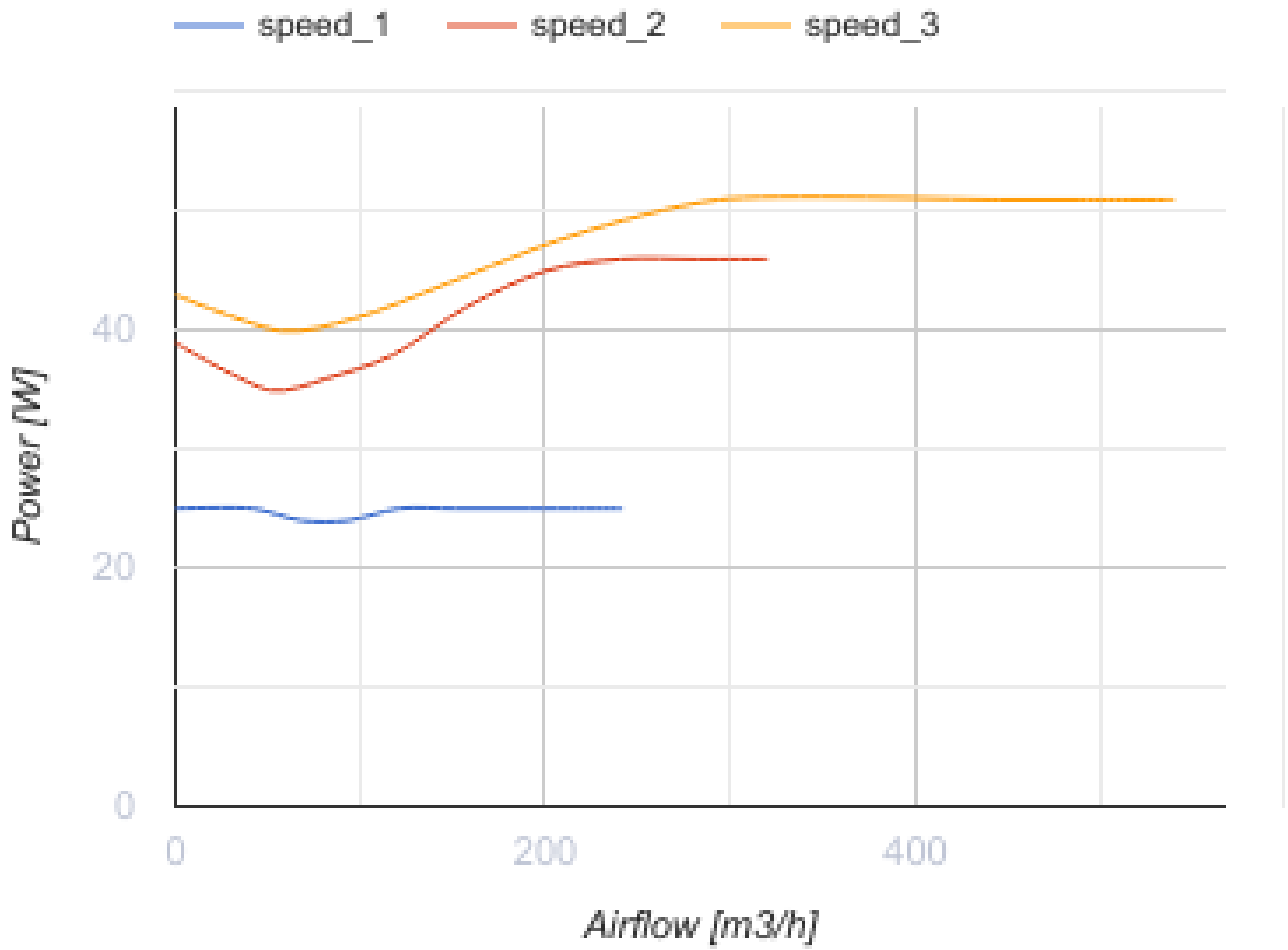





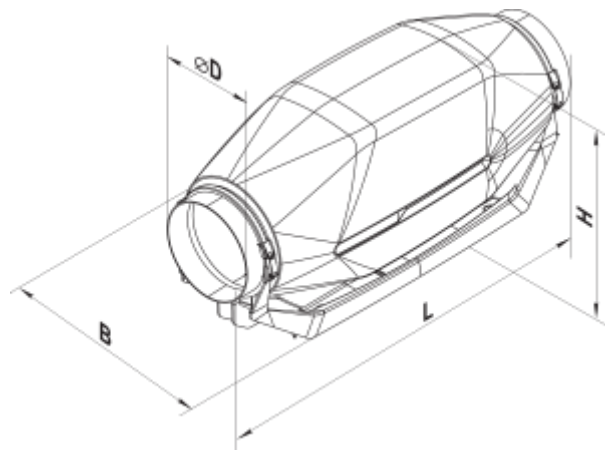

Dimensions

$\varnothing D$	B	L	H
150 (160)	253	606	273









Accessories

For round ducts











Name	Photo	Description
SR 150/600		Silencer is applied for noise absorption produced during the ventilating equipment operation and spread along the ducting systems
SR 150/900		Silencer is applied for noise absorption produced during the ventilating equipment operation and spread along the ducting systems
SR 150/1200		Silencer is applied for noise absorption produced during the ventilating equipment operation and spread along the ducting systems
SR 160/600		Silencer is applied for noise absorption produced during the ventilating equipment operation and spread along the ducting systems
SR 160/900		Silencer is applied for noise absorption produced during the ventilating equipment operation and spread along the ducting systems
SR 160/1200		Silencer is applied for noise absorption produced during the ventilating equipment operation and spread along the ducting systems

For round ducts

Name	Photo	Description
FB 150		Panel filters
FB 160		Panel filters
FBK 150-4		Pocket filter
FBK 150-5		Pocket filter
FBK 150-7		Pocket filter
FBK 160-4		Pocket filter



FBK 160-5		Pocket filter
FBK 160-7		Pocket filter

Electrical heaters





Name	Photo	Description
NK 150-1,2-1		Duct electric heater
NK 150-1,7-1		Duct electric heater
NK 150-2,0-1		Duct electric heater
NK 150-2,4-1		Duct electric heater
NK 150-3,4-1		Duct electric heater
NK 160-1,2-1		Duct electric heater
NK 160-1,7-1		Duct electric heater
NK 160-2,0-1		Duct electric heater
NK 160-2,4-1		Duct electric heater
NK 160-3,4-1		Duct electric heater

Water heaters

Name	Photo	Description
NKV 150-2		Duct water heaters are designed for heating of supply air in round ventilation systems. They can be also applied in supply or supply and exhaust ventilating units

NKV 150-4		Duct water heaters are designed for heating of supply air in round ventilation systems. They can be also applied in supply or supply and exhaust ventilating units
NKV 160-2		Duct water heaters are designed for heating of supply air in round ventilation systems. They can be also applied in supply or supply and exhaust ventilating units
NKV 160-4		Duct water heaters are designed for heating of supply air in round ventilation systems. They can be also applied in supply or supply and exhaust ventilating units



For round ducts

Name	Photo	Description
KOM 150		Spring-loaded backdraft damper for round ducts
KOM 160		Spring-loaded backdraft damper for round ducts
KR 150		Air damper for air flow control in round air ducts
KR 160		Air damper for air flow control in round air ducts

Speed control switches

Name	Photo	Description
P3-1-300		Switch

Speed controllers

Name	Photo	Description
RS-0.5-PS		Used in ventilation systems for switching on/off and speed control of single-phase fan motors with voltage control
RS-3.0-T		Applied in ventilation systems for speed switching ON/OFF and speed control of single-phase power-controlled motors
RS-1-400		Speed controller