

TwinFresh Comfo RA1-85-1 V.3



The TwinFresh Comfo user-friendly ventilator ensures fresh and clean air with a comfort level of humidity in your house

- Air flow in heat recovery mode: 43
- Sound pressure level LpA at 3 m: 34
- Sound pressure level LpA at 1 m: 44
- Heat exchanger type: Regenerative
- Filter: G3 (G4 F7 optional), G3 (G4 F7 опционально)
- Sound insulation
- Motor type: EC
- Control: Remote Control
- Casing material: Plastic
- Humidity sensor: Built-in

	Unit of measurement	TwinFresh Comfo RA1-85-1 V.3		
Speed	-	3		
Minimum supply voltage	V	100		
Maximum supply voltage	V	240		
Power supply frequency	Hz	50/60		
Rated power	W	4.74	6.56	9.65
Unit current	A	0.034	0.050	0.071
Air flow in ventilation mode	m ³ /h	36	59	85
Air flow in heat recovery mode	m ³ /h	18	30	43
Sound pressure level LpA at 3 m	dB(A)	19	25	34
Sound pressure level LpA at 1 m	dB(A)	29	35	44
Heat recovery efficiency, max	%	90		
Heat exchanger type	-	Regenerative		
Heat exchanger material	-	Ceramic		
Filter	-	G3 (G4 F7 optional), G3 (G4 F7 опционально)		
Transported air temperature (max)	°C	40		
Transported air temperature (min)	°C	-20		
Ambient air temperature min	°C	1		
Ambient air temperature max	°C	40		
Ambient air humidity max	%	65		





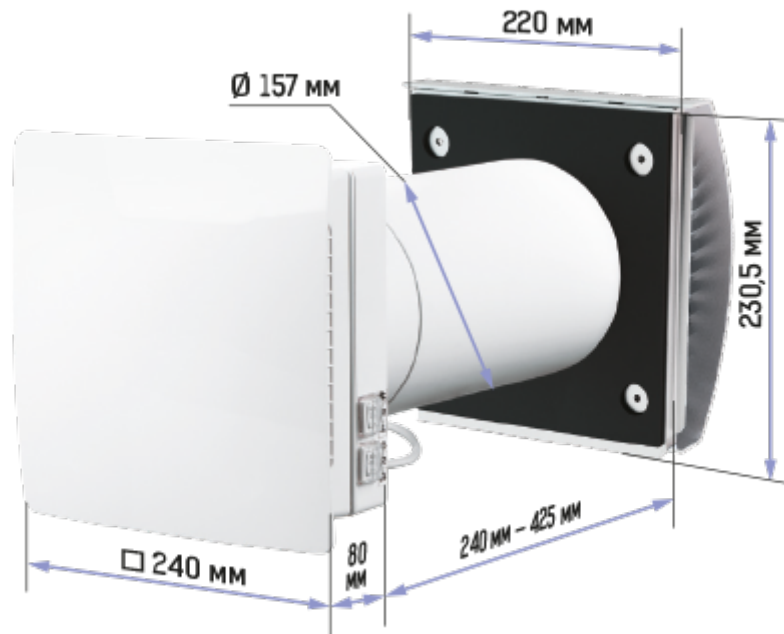

Ingress protection rating	-	IP24
---------------------------	---	------















Dimensions



Accessories

Other accessories

Name	Photo	Description
EH-14 beige 160		Plastic outer hood
EH-14 black 160		Plastic outer hood
EH-14 brown 160		Plastic outer hood
EH-14 chrome 160		Plastic outer hood
EH-14 grey 160		Plastic outer hood
EH-14 terracotta 160		Plastic outer hood

EH-14 white 160		Plastic outer hood
EH-17 beige 160		Plastic outer hood
EH-17 black 160		Plastic outer hood
EH-17 brown 160		Plastic outer hood
EH-17 grey 160		Plastic outer hood
EH-17 terracotta 160		Plastic outer hood
EH-17 white 160		Plastic outer hood
EH-2 chrome 160		Outer hood for thin walls
EH-2 grey 160		Outer hood for thin walls
EH-13 chrome 160		Outer hood for cold climate
EH-13 white 160		Outer hood for cold climate
MVVM 162 05		Outer ventilation hood
TwinFresh R-50		Kit for pre-installation
TwinFresh Comfo RA1-50 V.3 completion kit		Completion kit (for the TwinFresh Comfo RA1-50 V.3 model)
RC TwinFresh Comfo R-50		Remote control

SF TwinFresh R-50 G3		G3 filter kit (2 pcs.)
SFC 150x50 F7		Filter
SFC 150x50 G4		Filter

Metal

Name	Photo	Description
MVMO 150 bV1s An		Supply and exhaust round edge-raised metal grilles

Flat duct

Name	Photo	Description
3805		Wall mounting
3810		Wall mounting