

TwinFresh Easy-D RL7-50-17



Single-room heat regeneration unit. Air capacity up to 50 m³/h.

- Air flow in heat recovery mode: 50
- Sound pressure level LpA at 3 m: 20
- Sound pressure level LpA at 1 m: 29
- Heat exchanger type: Regenerative
- Filter: G3 (опция: F8), G3 (option: F8)
- Sound insulation
- Motor type: EC
- Control: Wired control panel
- Casing material: Plastic

	Unit of measurement	TwinFresh Easy-D RL7-50-17		
Speed	-	3		
Minimum supply voltage	V	100		
Maximum supply voltage	V	240		
Power supply frequency	Hz	50/60		
Rated power	W	2.37	3.80	7.61
Unit current	A	0.033	0.047	0.080
Air flow in ventilation mode	m ³ /h	15	35	50
Air flow in heat recovery mode	m ³ /h	15	35	50
Sound pressure level LpA at 3 m	dB(A)	12	18	20
Sound pressure level LpA at 1 m	dB(A)	21	27	29
Heat recovery efficiency, max	%	92		
Heat exchanger type	-	Regenerative		
Heat exchanger material	-	Ceramic		
Filter	-	G3 (опция: F8), G3 (option: F8)		
Transported air temperature (max)	°C	40		
Transported air temperature (min)	°C	-15		
Ambient air temperature min	°C	1		
Ambient air temperature max	°C	40		
Ambient air humidity max	%	65		

Ingress protection rating	-	IP24
---------------------------	---	------

Dimensions

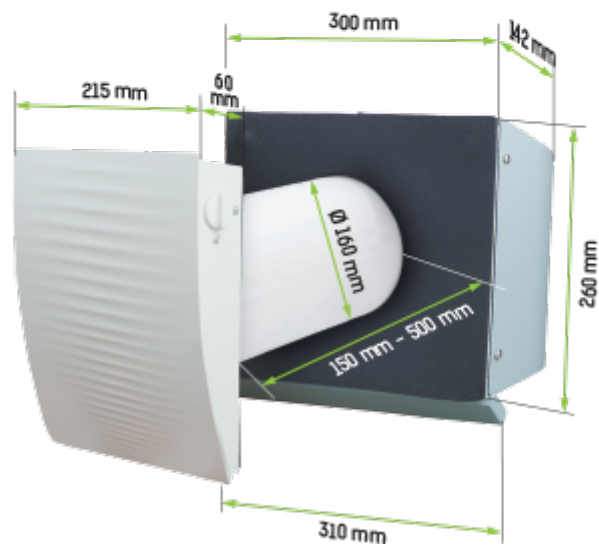
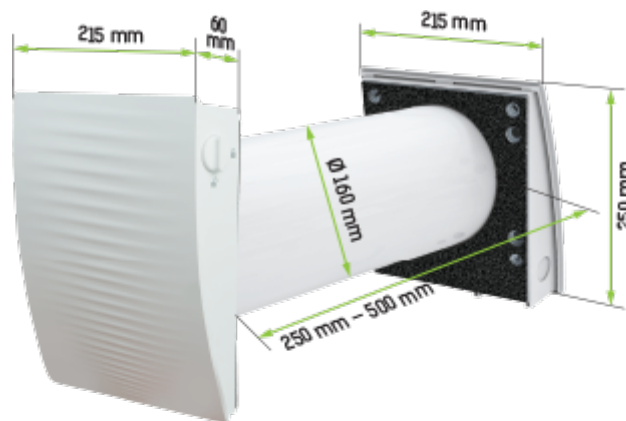
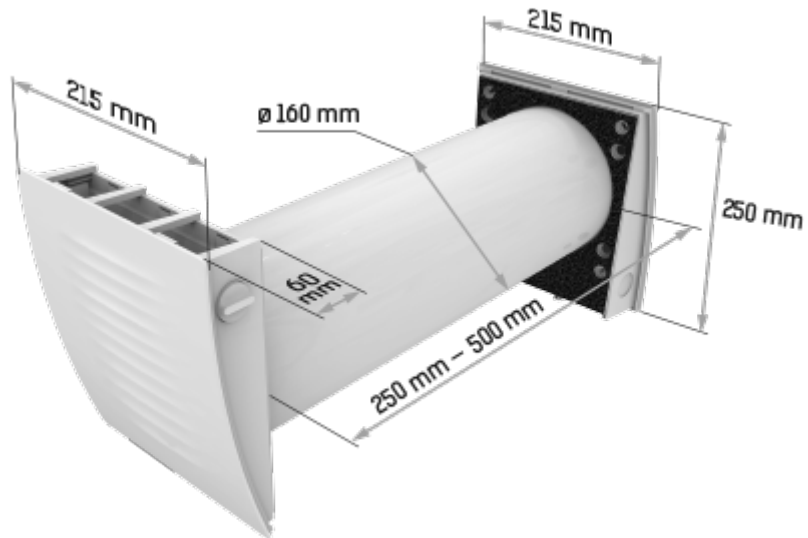

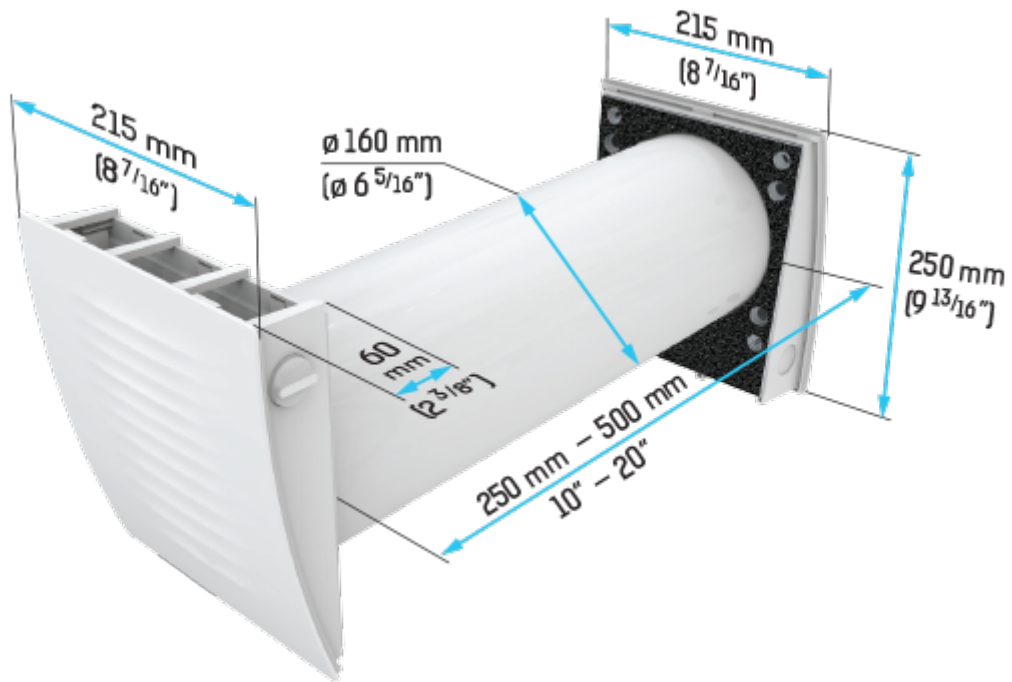



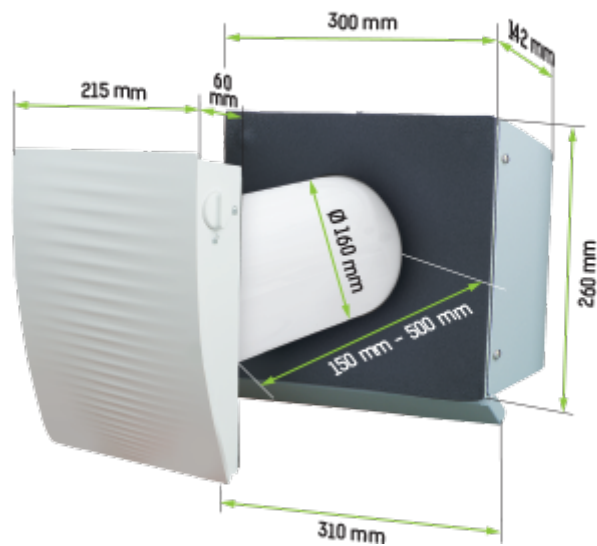















with a hood for thin walls











Accessories

Other accessories

Name	Photo	Description
SF TwinFresh Easy R-50 F8		F8 Filter
SF TwinFresh Easy R-50 G3		G3 filter kit (2 pcs.)
RK TwinFresh Easy RL-50		Remote control

KV TwinFresh Easy RL-50		LCD control panel
EH-2 grey 160		Outer hood for thin walls
EH-2 chrome 160		Outer hood for thin walls
NP white 160		Angular mounting kit
NP chrome 160		Angular mounting kit
Duct 160-500		Air duct
Duct 160-700		Air duct
MVVM 162 05		Outer ventilation hood
EH-14 white 160		Plastic outer hood
EH-14 chrome 160		Plastic outer hood
S3 TwinFresh		Cartridge for cold climate
EH-13 white 160		Outer hood for cold climate
EH-13 chrome 160		Outer hood for cold climate
EH-14 brown 160		Plastic outer hood
EH-14 black 160		Plastic outer hood

EH-14 grey 160		Plastic outer hood
EH-14 beige 160		Plastic outer hood
EH-14 terracotta 160		Plastic outer hood
EH-17 white 160		Plastic outer hood
EH-17 brown 160		Plastic outer hood
EH-17 black 160		Plastic outer hood
EH-17 grey 160		Plastic outer hood
EH-17 beige 160		Plastic outer hood
EH-17 terracotta 160		Plastic outer hood

Metal

Name	Photo	Description
MVMO 150 bV1s An		Supply and exhaust round edge-raised metal grilles