

# TwinFresh Easy RL7-50-17



Single-room HRV unit with ceramic heat exchanger and an air flow of 50 m<sup>3</sup>/h

- Air flow in heat recovery mode: 25
- Sound pressure level LpA at 3 m: 20
- Sound pressure level LpA at 1 m: 29
- Heat recovery efficiency: 92
- Heat exchanger type: Regenerative
- Filter: F7
- Sound insulation
- Motor type: EC
- Control: Wired control panel
- Casing material: Plastic

	Unit of measurement	TwinFresh Easy RL7-50-17		
Speed	-	3		
Minimum supply voltage	V	100		
Maximum supply voltage	V	240		
Power supply frequency	Hz	50/60		
Rated power	W	1.00	2.10	4.30
Unit current	A	0.017	0.025	0.041
Air flow in ventilation mode	m <sup>3</sup> /h	15	35	50
Air flow in heat recovery mode	m <sup>3</sup> /h	8	15	25
Sound pressure level LpA at 3 m	dB(A)	12	18	20
Sound pressure level LpA at 1 m	dB(A)	21	27	29
Heat recovery efficiency	%	92		
Heat recovery efficiency, max	%	92		
Heat exchanger type	-	Regenerative		
Heat exchanger material	-	Ceramic		
Filter	-	F7		
Transported air temperature (max)	°C	40		
Transported air temperature (min)	°C	-15		
Ambient air temperature min	°C	1		
Ambient air temperature max	°C	40		

Ambient air humidity max	%	65
Ingress protection rating	-	IP24

## Dimensions

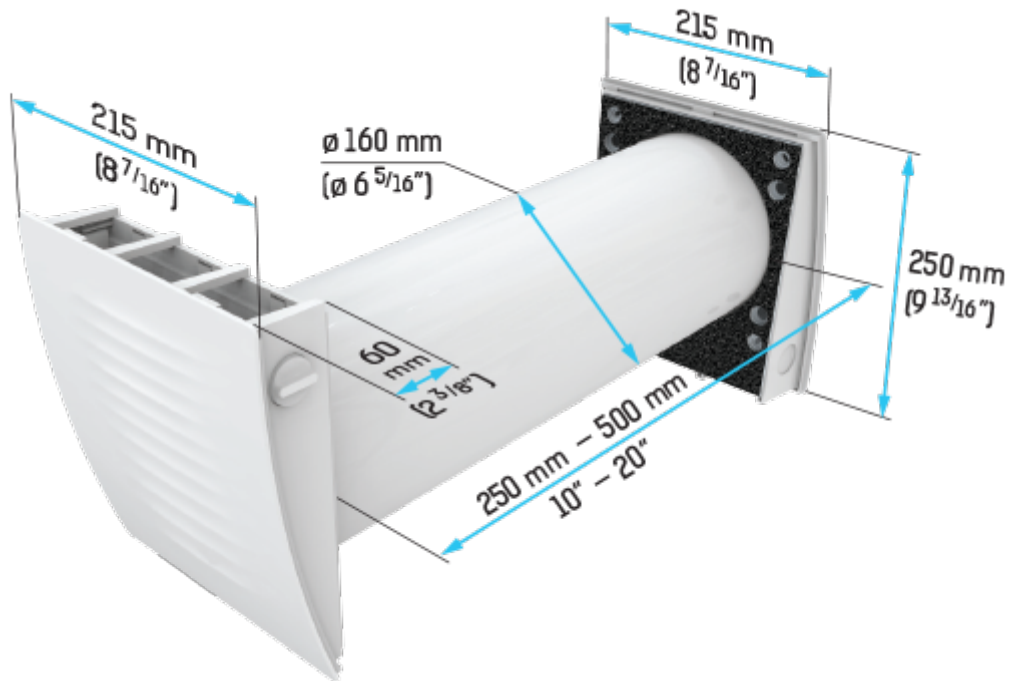

with a hood for thin walls

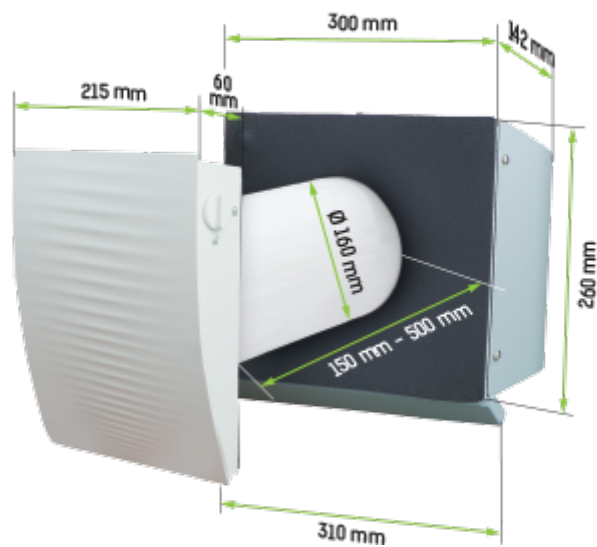











## Accessories

### Metal



Name	Photo	Description
------	-------	-------------

<a href="#">MVMO 150 bV1s An</a>		Supply and exhaust round edge-raised metal grilles
----------------------------------	-----------------------------------------------------------------------------------	----------------------------------------------------

### Other accessories

Name	Photo	Description
EH-2 grey 160		Outer hood for thin walls
EH-2 chrome 160		Outer hood for thin walls
NP white 160		Angular mounting kit
NP chrome 160		Angular mounting kit
Duct 160-500		Air duct
Duct 160-700		Air duct
S3 TwinFresh		Cartridge for cold climate
EH-13 white 160		Outer hood for cold climate
EH-13 chrome 160		Outer hood for cold climate
SF2 TwinFresh F7		Fine filter F7 Contents: • plastic filter holder (1 pc.) • F7 filter (1 pc.) The F7 filter reduces air flow to 40 m <sup>3</sup> /h

### Plastic

Name	Photo	Description
<a href="#">MVVM 162 05</a>		Outer ventilation hood
<a href="#">EH-14 white 160</a>		Plastic outer hood

[EH-14 chrome 160](#)



Plastic outer hood