

Uni ERV L A14



Centralised ventilation unit for small apartments

- Maximum airflow: 160
- Sound pressure level LpA at 3 m: 33
- Sound pressure level LpA at 1 m: 42
- Heat exchanger type: Counter flow
- Extract filter: Coarse 90% / G4
- Supply filter: ePM1 70% / F7 (G4 option)
- Sound insulation
- Motor type: EC
- Enthalpy heat exchanger
- Bypass: Auto
- BMS protocol: ModBus
- Control: Smartphone
- Casing material: Galvanized steel
- Humidity sensor: Optional
- CO2 sensor: Optional
- VOC sensor: Optional
- PM2.5 sensor: Optional
- Temperature sensor: Built-in

	Unit of measurement	Uni ERV L A14		
Connected air duct size	mm	125		
Speed	-	3		
Minimum supply voltage	V	230		
Maximum supply voltage	V	230		
Power supply frequency	Hz	50/60		
Rated power	W	58		
Unit current	A	0.5		
Maximum airflow	m ³ /h	60	90	160
Sound pressure level LpA at 3 m	dB(A)	33		
Sound pressure level LpA at 1 m	dB(A)	42		
Heat recovery efficiency, max	%	89		
Heat exchanger type	-	Counter flow		
Heat exchanger material	-	Enthalpy		
Weight	kg	31		
Extract filter	-	Coarse 90% / G4		
Supply filter	-	ePM1 70% / F7 (G4 option)		
Transported air temperature (max)	°C	40		
Transported air temperature (min)	°C	-25		

Dimensions

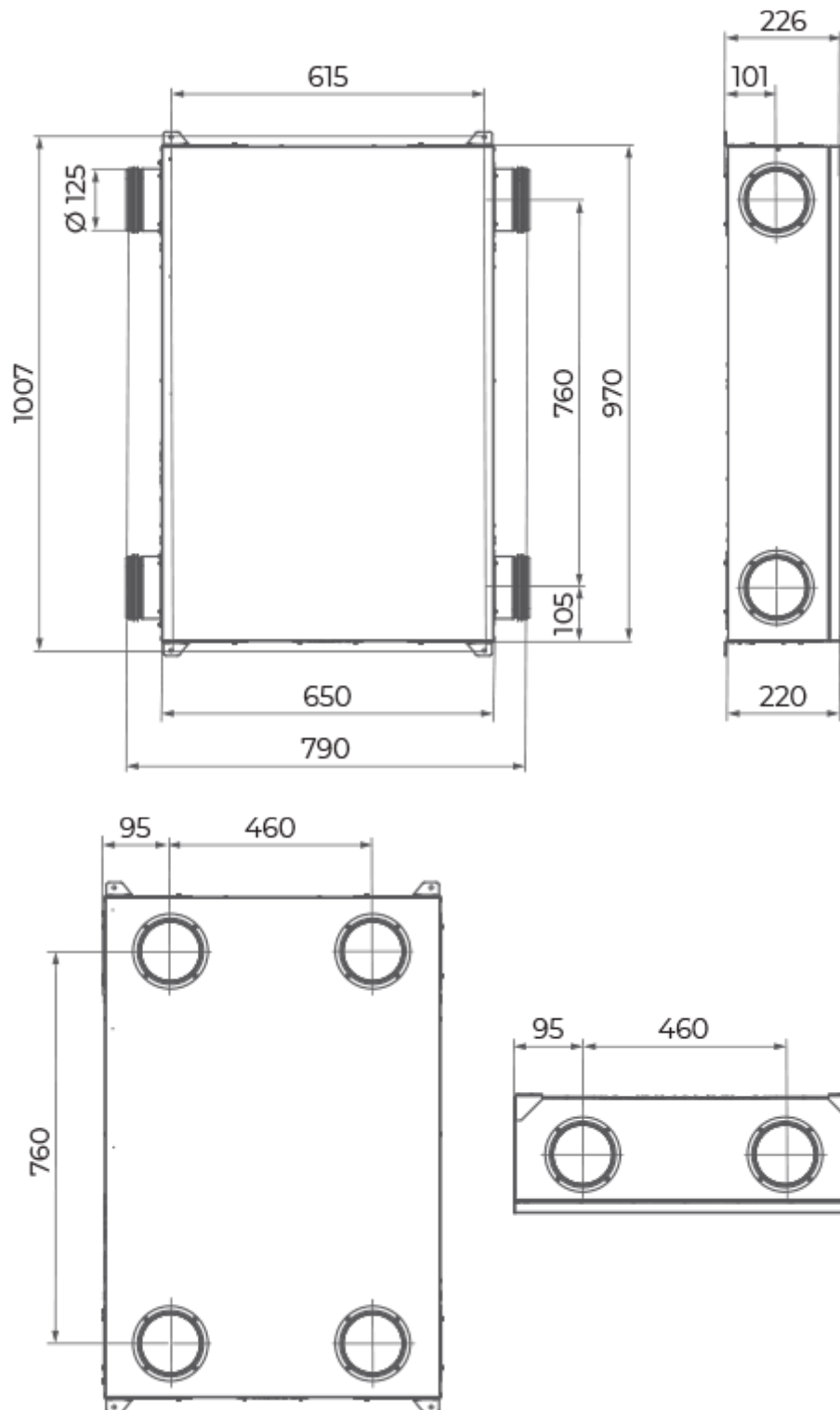





Accessories

Other accessories



Name	Photo	Description
------	-------	-------------

SF 233x175x22 G4		Panel filter G4
SF 233x175x22 F7		F7 panel filter

Sensors

Name	Photo	Description
HV2		Humidity sensor
HR-S		Electro-mechanical humidistats
CO2-1		CO2 sensors
CO2-2		CO2 sensors
CO2-3		CO2 sensor

Electrical heaters

Name	Photo	Description
NKD 125-0,6-1 A21 V.2		Duct heater for supply air post-heating with external control
NKD 125-0,8-1 A21 V.2		Duct heater for supply air post-heating with external control
NKD 125-1,2-1 A21 V.2		Duct heater for supply air post-heating with external control