

Uni R A21

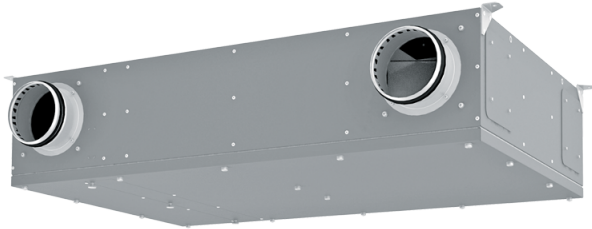

Centralised ventilation unit for small apartments

- Maximum airflow: 160
- Sound pressure level LpA at 3 m: 33
- Sound pressure level LpA at 1 m: 42
- Heat exchanger type: Counter flow
- Extract filter: Coarse 90% / G4
- Supply filter: ePM1 70% / F7 (G4 option)
- Sound insulation
- Motor type: EC
- Bypass: Auto
- BMS protocol: ModBus
- Control: Smartphone
- Casing material: Galvanized steel
- Humidity sensor: Optional
- CO2 sensor: Optional
- VOC sensor: Optional
- PM2.5 sensor: Optional
- Temperature sensor: Built-in

	Unit of measurement	Uni R A21		
Connected air duct size	mm	125		
Speed	-	3		
Minimum supply voltage	V	230		
Maximum supply voltage	V	230		
Power supply frequency	Hz	50/60		
Rated power	W	58		
Unit current	A	0.5		
Maximum airflow	m ³ /h	60	90	160
Sound pressure level LpA at 3 m	dB(A)	33		
Sound pressure level LpA at 1 m	dB(A)	42		
Heat recovery efficiency, max	%	95		
Heat exchanger type	-	Counter flow		
Heat exchanger material	-	Polystyrene		
Weight	kg	31		
Extract filter	-	Coarse 90% / G4		
Supply filter	-	ePM1 70% / F7 (G4 option)		
Transported air temperature (max)	°C	40		
Transported air temperature (min)	°C	-25		

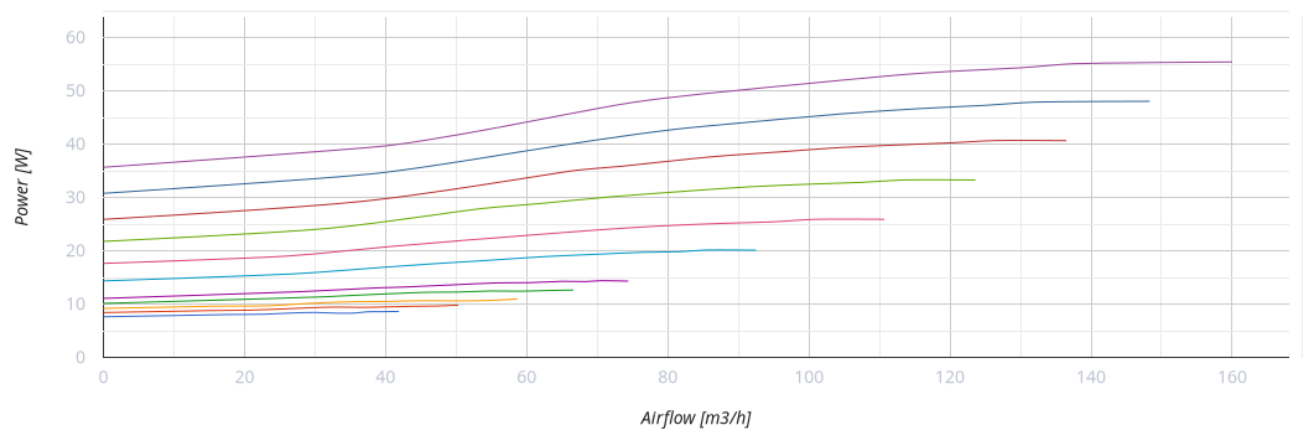
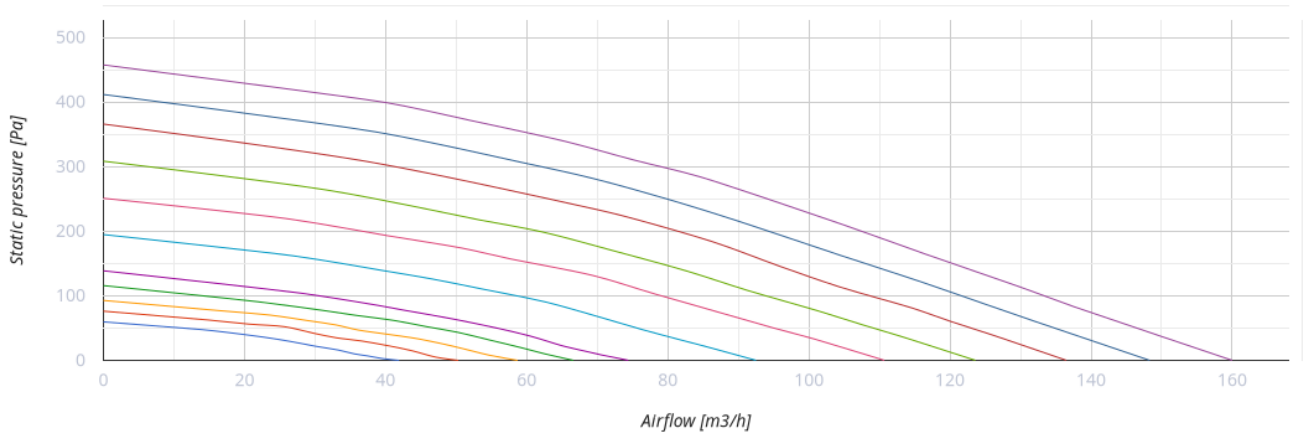

Dimensions

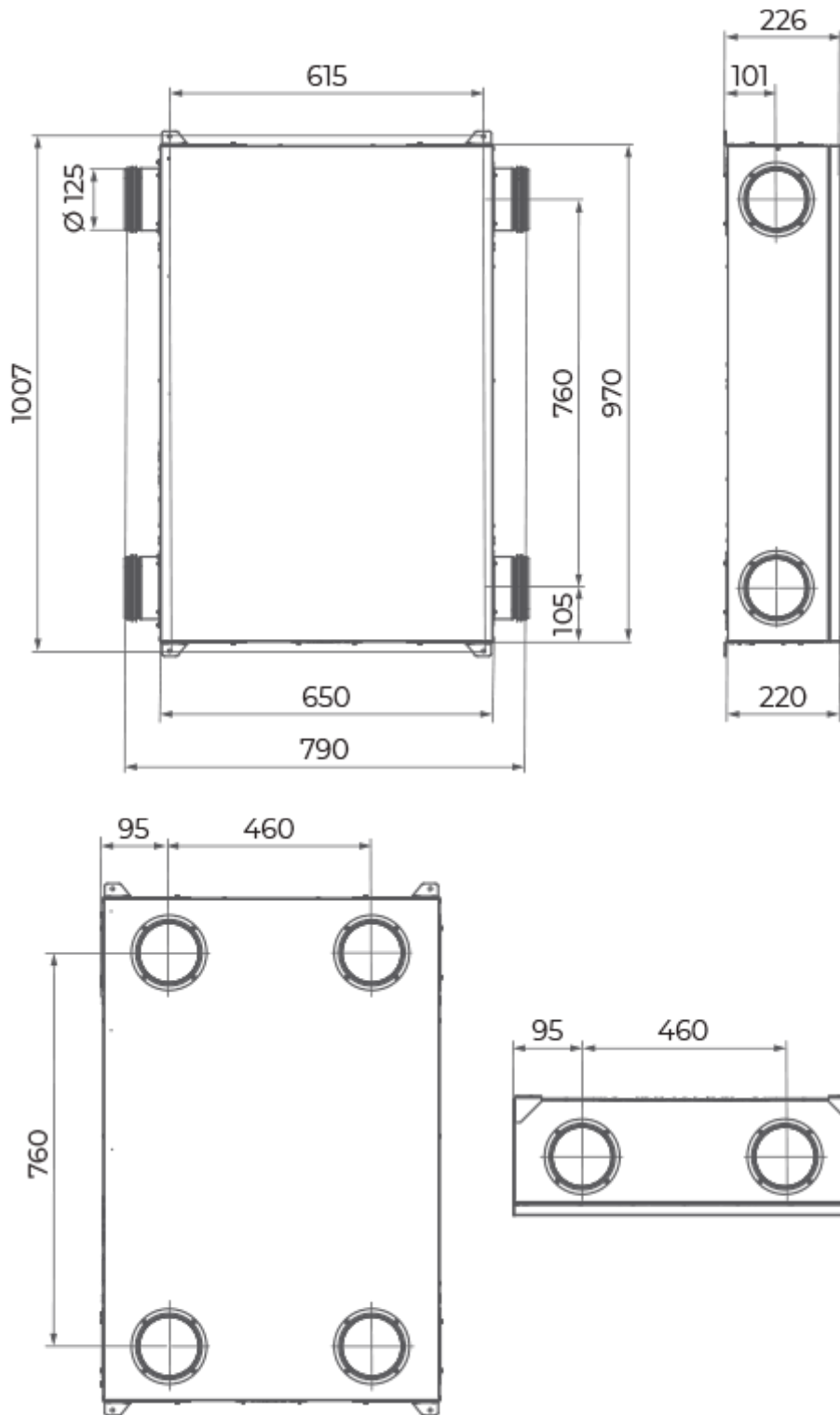



Accessories

Other accessories







Name	Photo	Description
SF 233x175x22 G4		Panel filter G4

SF 233x175x22 F7		F7 panel filter
------------------	---	-----------------

Control Panels for AHU

Name	Photo	Description
A22		The A22/A22 WiFi control panels are used for control of industrial and domestic air handling units with an A21 automation system.
A22 WIFI		The A22/A22 WiFi control panels are used for control of industrial and domestic air handling units with an A21 automation system.
A25		The control panel with a sensor display

Sensors



Name	Photo	Description
HV2		Humidity sensor
HR-S		Electro-mechanical humidistats
CO2-1		CO2 sensors
CO2-2		CO2 sensors
CO2-3		CO2 sensor
DPWC11200		Humidity sensor

VOC sensors

Name	Photo	Description
DPWQ30600		VOC sensors

DPWQ40200		CO2 sensor
---------------------------	---	------------

Electrical heaters

Name	Photo	Description
NKD 125-0,6-1 A21 V.2		Duct heater for supply air post-heating with external control
NKD 125-0,8-1 A21 V.2		Duct heater for supply air post-heating with external control
NKD 125-1,2-1 A21 V.2		Duct heater for supply air post-heating with external control

Ecodesign

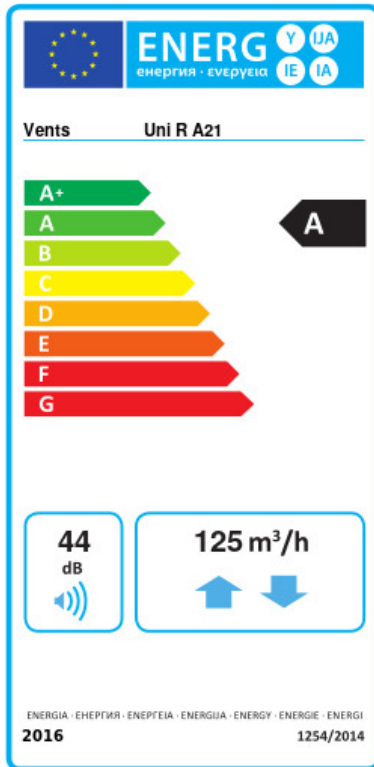

Trademark	Vents					
Model	Uni R A21					
Specific energy consumption (SEC) (kWh/(m ² /a))	Cold		Average		Warm	
	-78.8	A+	-41	A	-16.8	E
Type of ventilation unit	Bidirectional					
Type of drive installed	Variable speed					
Type of heat recovery system	Recuperative					
Thermal efficiency of heat recovery (%)	81					
Maximum flow rate (m ³ /h)	125					
Electric power input (W)	52					
Reference flow rate (m ³ /s)	0.027					
Reference pressure difference (Pa)	50					
Specific power input (SPI) (W/(m ³ /h))	0.271					
Control typology	Local demand control					
Maximum internal leakage rates (%)	2.7					
Maximum external leakage rates (%)	2.7					
Airflow sensitivity at +20 Pa and -20 Pa (%)	0					
Declared typology	RVU BVU					
Sound power level (dB(A))	44					
The annual electricity consumption (AEC) (kWh/a)	Cold		Average		Warm	
	725		188		143	
The annual heating saved (AHS) (kWh/a)	Cold		Average		Warm	
	8817		4507		2038	