

# VKHC 310 EC



Roof centrifugal fans with EC-motors

- Maximum airflow: 2700
- Sound pressure level LpA at 3 m: 49
- Motor type: EC
- Impeller type: Centrifugal backward curved blades
- Casing material: Coated steel

	Unit of measurement	VKHC 310 EC
Speed	-	1
Phases	-	1
Minimum supply voltage	V	230
Maximum supply voltage	V	230
Power supply frequency	Hz	50/60
Rated power	W	408
Unit current	A	1.79
Maximum airflow	m <sup>3</sup> /h	2700
rotation speed at 50hz	-	2600
Sound pressure level LpA at 3 m	dB(A)	49
Weight	kg	12
Transported air temperature (max)	°C	60
Transported air temperature (min)	°C	-25
Ingress protection rating	-	IPX4
Ingress protection rating of the drive	-	IP55

## Dimensions

H	ØD	ØD1	L	L1
254	623	285	420	330

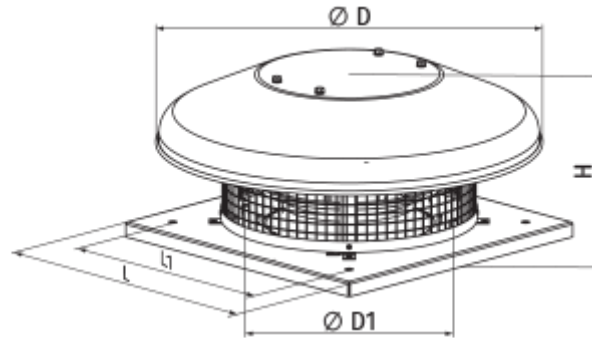

## Accessories

### Speed controllers

Name	Photo	Description
<a href="#">R-1/010</a>		Speed controller for EC motors

## Ecodesign

Trademark	Vents
Model	VKHC 310 EC
Type of drive installed	Integrated VSD
Type of heat recovery system	None
Nominal flow rate (m <sup>3</sup> /s)	0.404
Nominal external pressure (Pa)	462
Maximum external leakage rates (%)	2.7
Static efficiency (%)	52
Declared typology	NRVU UVU
Effective electric power input (kW)	0.408
Sound power level (dB(A))	68