

VKHC 4E 310



Centrifugal roof fans with horizontal air exhaust

- Maximum airflow: 2265
- Sound pressure level LpA at 3 m: 47
- Motor type: AC
- Impeller type: Centrifugal backward curved blades
- Casing material: Coated steel

	Unit of measurement	VKHC 4E 310	
Speed	-	1	
Phases	-	1	
Minimum supply voltage	V	230	
Maximum supply voltage	V	230	
Power supply frequency	Hz	50	60
Rated power	W	141	
Unit current	A	0.64	
Maximum airflow	m ³ /h	2265	
rotation speed at 50hz	-	1420	
Sound pressure level LpA at 3 m	dB(A)	47	
Weight	kg	11	
Transported air temperature (max)	°C	50	
Transported air temperature (min)	°C	-25	
Ingress protection rating	-	IPX4	
Ingress protection rating of the drive	-	IP44	

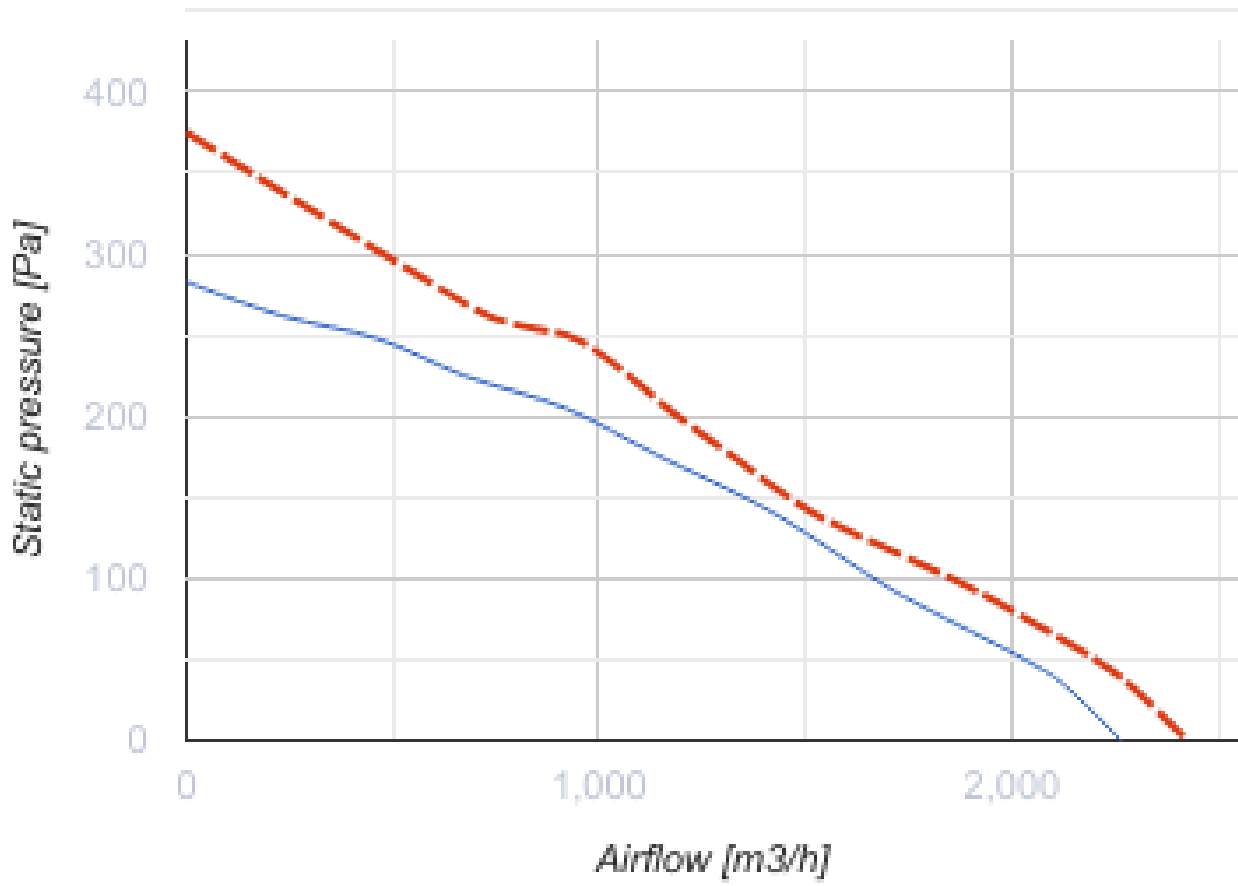

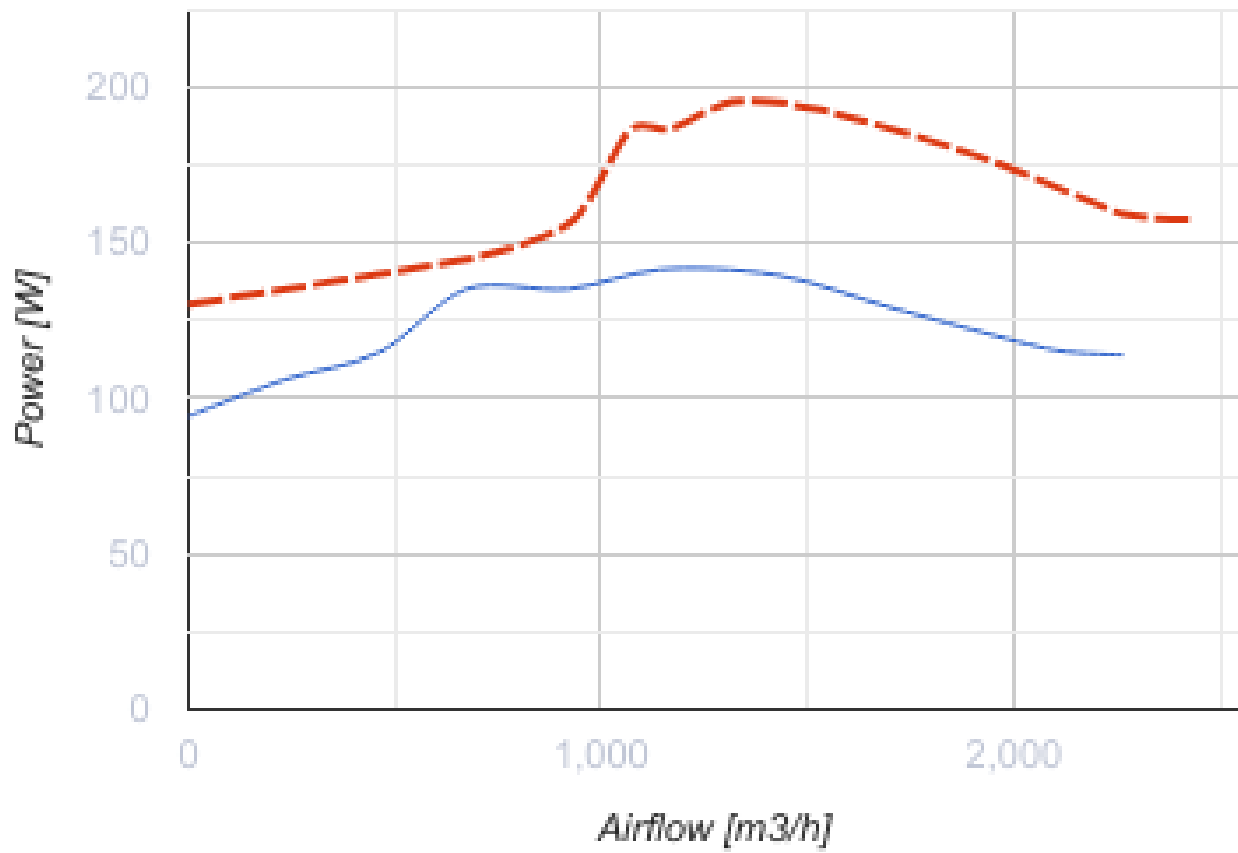





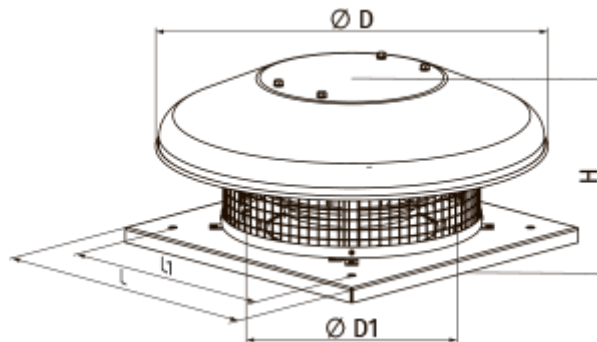





Dimensions

H	ØD	ØD1	L	L1
277	623	285	420	330



Accessories

Speed controllers

Name	Photo	Description
RSA5D-1,5-T		Three phase speed controller
RSA5D-3,5-T		Three phase speed controller
RSA5D-1,5-M		Three phase speed controller
RSA5D-2,5-M		Three phase speed controller
RSA5D-6,0-M		Three phase speed controller
RSA5D-8,0-M		Three phase speed controller
RSA5D-11,0-M		Three phase speed controller
RSA5D-12,0-M		Three phase speed controller
RS-3,0-T		Applied in ventilation systems for speed switching ON/OFF and speed control of single-phase power-controlled motors
RS-5,0-T		Applied in ventilation systems for speed switching ON/OFF and speed control of single-phase power-controlled motors
RS-10,0-T		Applied in ventilation systems for speed switching ON/OFF and speed control of single-phase power-controlled motors

Ecodesign

Trademark	Vents
Model	VKHC 4E 310
Type of drive installed	External MSD or VSD
Type of heat recovery system	None
Nominal flow rate (m ³ /s)	0.317
Nominal external pressure (Pa)	176
Maximum external leakage rates (%)	2.7
Static efficiency (%)	40.4
Effective electric power input (kW)	0.141
Sound power level (dB(A))	67
Declared typology	NRVU UVU