

VKHCA 250 EC



Roof centrifugal fans with EC-motors

- Maximum airflow: 1500
- Sound pressure level LpA at 3 m: 54
- Motor type: EC
- Impeller type: Centrifugal backward curved blades
- Casing material: Aluminium

	Unit of measurement	VKHCA 250 EC
Speed	-	1
Phases	-	1
Minimum supply voltage	V	230
Maximum supply voltage	V	230
Power supply frequency	Hz	50/60
Rated power	W	164
Unit current	A	1.25
Maximum airflow	m ³ /h	1500
Sound pressure level LpA at 3 m	dB(A)	54
Weight	kg	8
Transported air temperature (max)	°C	60
Transported air temperature (min)	°C	-25
Ingress protection rating	-	IPX4
Ingress protection rating of the drive	-	IP55

Dimensions

H	ØD	ØD1	L	L1
224	503	285	420	330

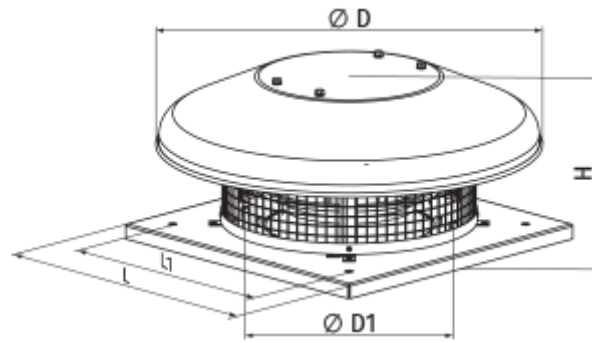







Accessories

Speed controllers

Name	Photo	Description
R-1/010		Speed controller for EC motors

For round ducts

Name	Photo	Description
SR 250/600		Silencer is applied for noise absorption produced during the ventilating equipment operation and spread along the ducting systems
SR 250/900		Silencer is applied for noise absorption produced during the ventilating equipment operation and spread along the ducting systems
SR 250/1200		Silencer is applied for noise absorption produced during the ventilating equipment operation and spread along the ducting systems
SRF 250/600		Silencer is applied for noise absorption produced during the ventilating equipment operation and spread along the ducting systems
SRF 250/900		Silencer is applied for noise absorption produced during the ventilating equipment operation and spread along the ducting systems
SRF 250/2000		Silencer is applied for noise absorption produced during the ventilating equipment operation and spread along the ducting systems

For round ducts

Name	Photo	Description
KOM 250		Spring-loaded backdraft damper for round ducts

[KOMu 250](#)



Spring-loaded backdraft damper for round ducts