

VKHCA 2E 250



Centrifugal roof fans with horizontal air exhaust

- Maximum airflow: 1485
- Sound pressure level LpA at 3 m: 54
- Motor type: AC
- Impeller type: Centrifugal backward curved blades
- Casing material: Aluminium

	Unit of measurement	VKHCA 2E 250	
Speed	-	1	
Phases	-	1	
Minimum supply voltage	V	230	
Maximum supply voltage	V	230	
Power supply frequency	Hz	50	60
Rated power	W	184	
Unit current	A	0.81	
Maximum airflow	m ³ /h	1485	
rotation speed at 50hz	-	2480	
Sound pressure level LpA at 3 m	dB(A)	54	
Weight	kg	8	
Transported air temperature (max)	°C	50	
Transported air temperature (min)	°C	-25	
Ingress protection rating	-	IPX4	
Ingress protection rating of the drive	-	IP44	

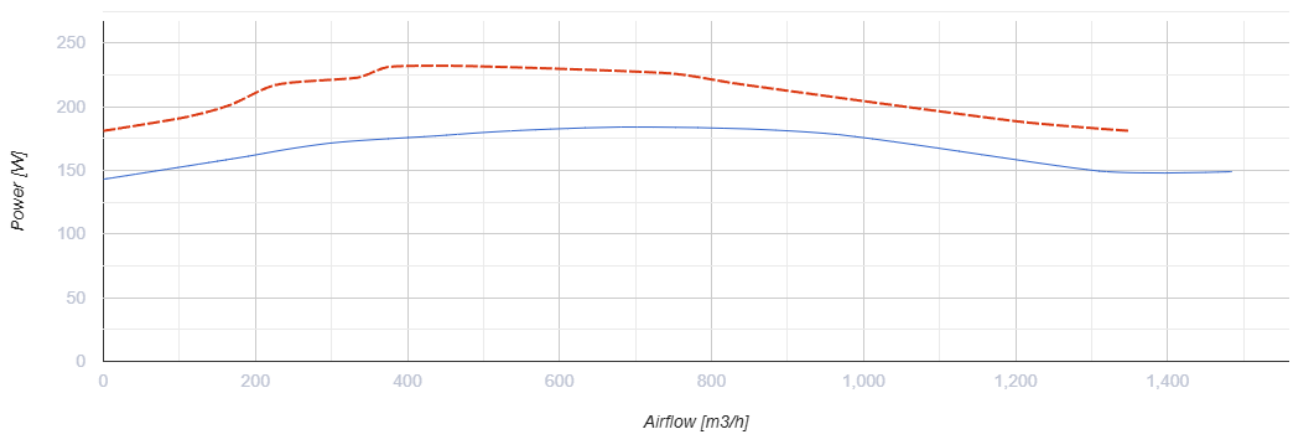
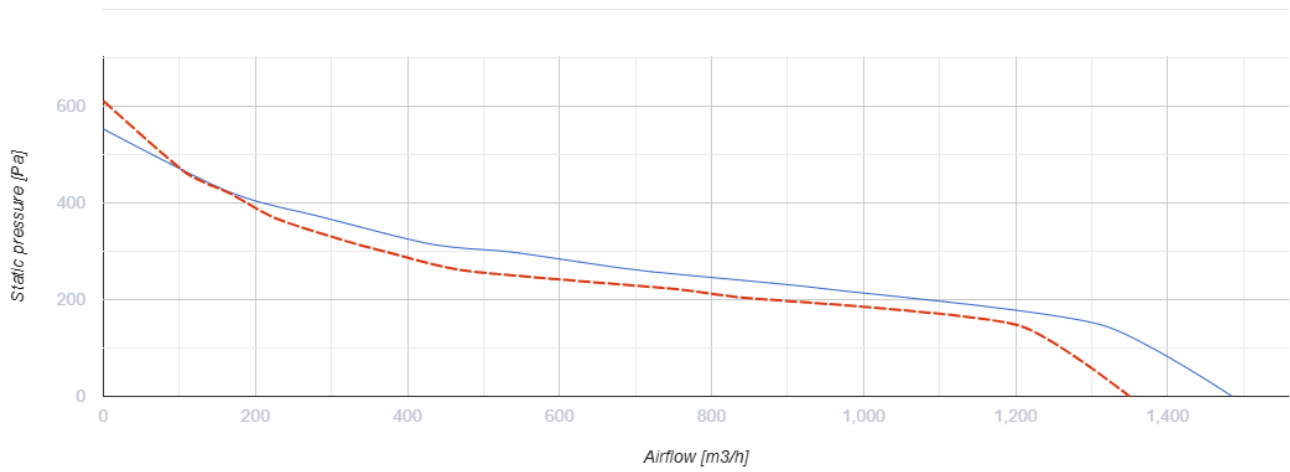

Dimensions



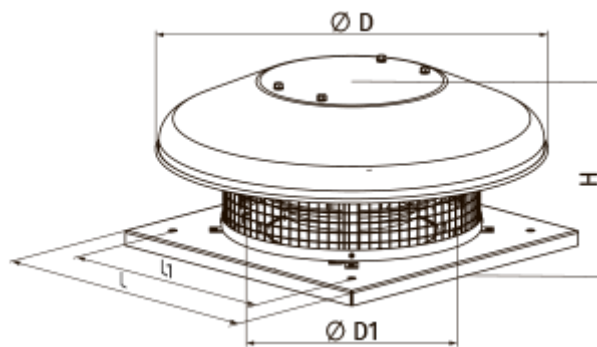











H	ØD	ØD1	L	L1
224	503	285	420	330



Accessories

Speed controllers

Name	Photo	Description
------	-------	-------------

RSA5E-2-P		Speed control enables not only selecting the comfortable ventilation mode for the periodically visited premises but reducing the energy consumption for the ventilation
RS-1-400		Speed controller
RS-1-300		Speed controller
RSA5D-1,5-M		Three phase speed controller
RSA5D-3,5-T		Three phase speed controller
RSA5D-1,5-T		Three phase speed controller
RSA5D-2,5-M		Three phase speed controller
RSA5D-6,0-M		Three phase speed controller
RSA5D-8,0-M		Three phase speed controller
RSA5D-11,0-M		Three phase speed controller
RSA5D-12,0-M		Three phase speed controller
RS-3,0-T		Applied in ventilation systems for speed switching ON/OFF and speed control of single-phase power-controlled motors
RS-5,0-T		Applied in ventilation systems for speed switching ON/OFF and speed control of single-phase power-controlled motors
RS-10,0-T		Applied in ventilation systems for speed switching ON/OFF and speed control of single-phase power-controlled motors