

# VKHCA 4E 225



Centrifugal roof fans with horizontal air exhaust

- Maximum airflow: 760
- Sound pressure level LpA at 3 m: 45
- Motor type: AC
- Impeller type: Centrifugal backward curved blades
- Casing material: Aluminium

	Unit of measurement	VKHCA 4E 225
Speed	-	1
Phases	-	1
Minimum supply voltage	V	230
Maximum supply voltage	V	230
Power supply frequency	Hz	50
Rated power	W	49
Unit current	A	0.22
Maximum airflow	m <sup>3</sup> /h	760
rotation speed at 50hz	-	1400
Sound pressure level LpA at 3 m	dB(A)	45
Weight	kg	7
Transported air temperature (max)	°C	50
Transported air temperature (min)	°C	-25
Ingress protection rating	-	IPX4
Ingress protection rating of the drive	-	IP44





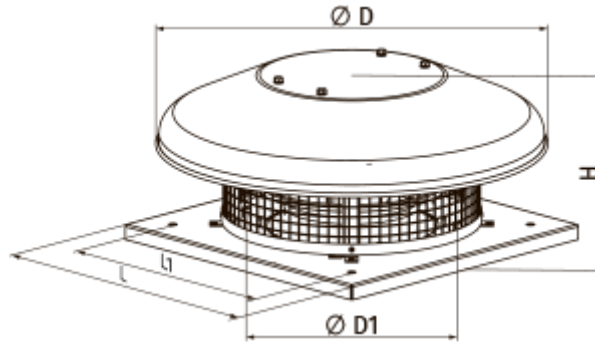



## Dimensions





H	ØD	ØD1	L	L1
193	503	210	330	245



## Accessories

### Speed controllers

Name	Photo	Description
<a href="#">RSA5E-2-P</a>		Speed control enables not only selecting the comfortable ventilation mode for the periodically visited premises but reducing the energy consumption for the ventilation
<a href="#">RS-1-400</a>		Speed controller
<a href="#">RS-1-300</a>		Speed controller
<a href="#">RSA5D-1,5-M</a>		Three phase speed controller
<a href="#">RSA5D-3,5-T</a>		Three phase speed controller
<a href="#">RSA5D-1,5-T</a>		Three phase speed controller
<a href="#">RSA5D-2,5-M</a>		Three phase speed controller
<a href="#">RSA5D-6,0-M</a>		Three phase speed controller
<a href="#">RSA5D-8,0-M</a>		Three phase speed controller

<a href="#">RSA5D-11,0-M</a>		Three phase speed controller
<a href="#">RSA5D-12,0-M</a>		Three phase speed controller
<a href="#">RS-3,0-T</a>		Applied in ventilation systems for speed switching ON/OFF and speed control of single-phase power-controlled motors
<a href="#">RS-5,0-T</a>		Applied in ventilation systems for speed switching ON/OFF and speed control of single-phase power-controlled motors
<a href="#">RS-10,0-T</a>		Applied in ventilation systems for speed switching ON/OFF and speed control of single-phase power-controlled motors