

VKPF 4D 500x300



Inline centrifugal fans for rectangular ducts

- Maximum airflow: 2350
- Sound pressure level LpA at 3 m: 56
- Motor type: AC
- Impeller type: Centrifugal forward curved blades
- Casing material: Galvanized steel
- Installation in any position

	Unit of measurement	VKPF 4D 500x300
Connected air duct size	mm	500x300
Speed	-	1
Minimum supply voltage	V	400
Maximum supply voltage	V	400
Power supply frequency	Hz	50
Rated power	W	855
Unit current	A	1.7
Maximum airflow	m ³ /h	2350
Sound pressure level LpA at 3 m	dB(A)	56
Weight	kg	33
Transported air temperature (max)	°C	50
Transported air temperature (min)	°C	-20
Ingress protection rating	-	IPX4
Ingress protection rating of the drive	-	IP44

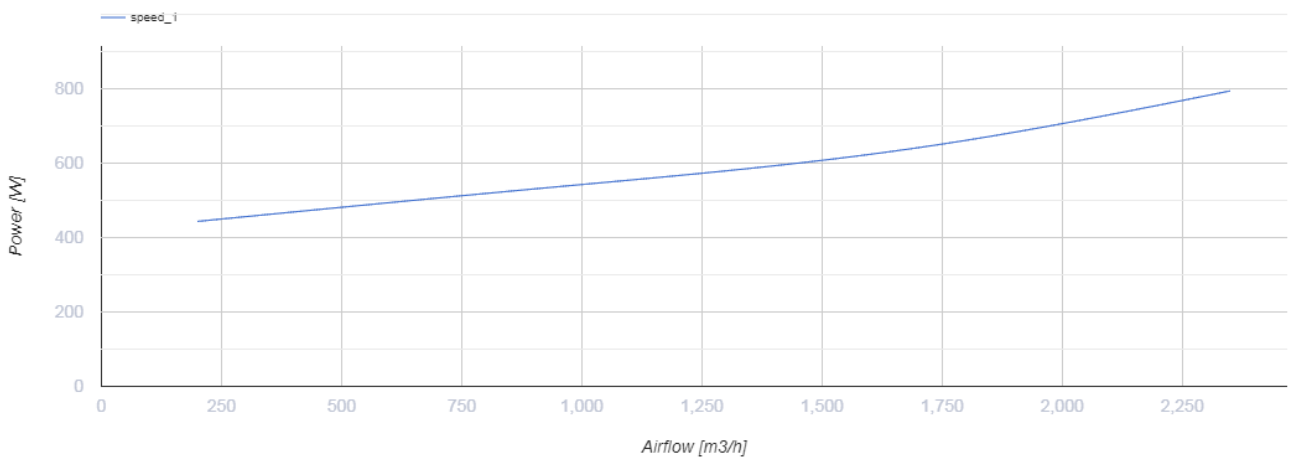
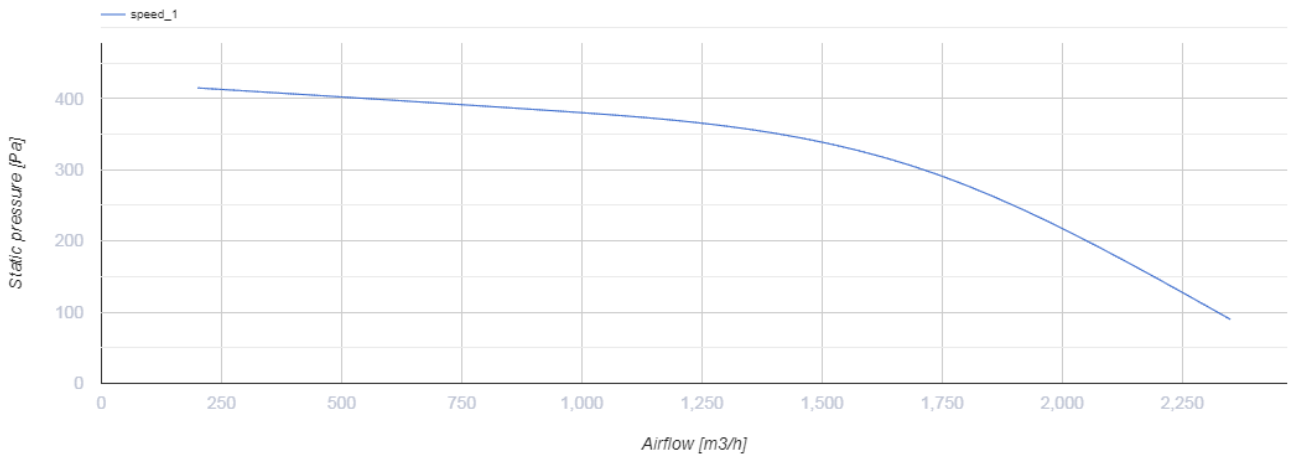

Dimensions

B	B1	B2	H	H1	H2	H3	L
500	520	540	300	320	340	365	680



Ecodesign

Trademark	Vents
Model	VKPF 4D 500x300
Type of drive installed	External MSD or VSD
Type of heat recovery system	None
Nominal flow rate (m ³ /s)	0.381
Nominal external pressure (Pa)	345
Maximum external leakage rates (%)	2.7
Static efficiency (%)	22.6
Declared typology	NRVU UVU
Effective electric power input (kW)	0.593
Sound power level (dB(A))	76