

# VKPF1 4D 600x350



Inline sound- and heat-insulated centrifugal fans for rectangular ducts

- Maximum airflow: 5020
- Sound pressure level LpA at 3 m: 52
- Sound insulation
- Motor type: AC
- Impeller type: Centrifugal forward curved blades
- Casing material: Galvanized steel
- Installation in any position

	Unit of measurement	VKPF1 4D 600x350
Connected air duct size	mm	600x350
Speed	-	1
Minimum supply voltage	V	400
Maximum supply voltage	V	400
Power supply frequency	Hz	50
Rated power	W	2460
Unit current	A	3.93
Maximum airflow	m <sup>3</sup> /h	5020
Sound pressure level LpA at 3 m	dB(A)	52
Weight	kg	72
Transported air temperature (max)	°C	40
Transported air temperature (min)	°C	-20
Ingress protection rating	-	IPX4
Ingress protection rating of the drive	-	IP44

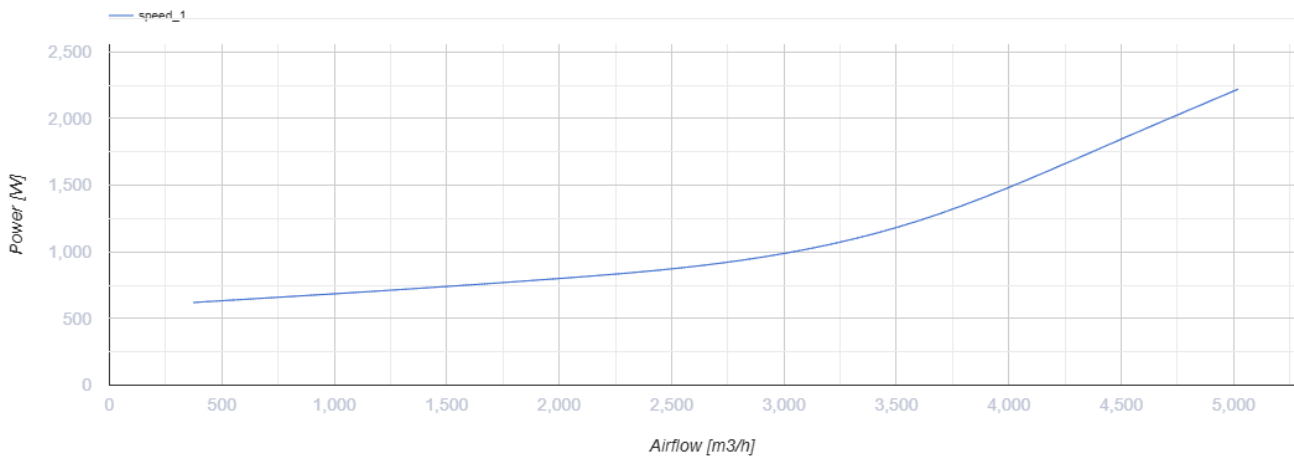
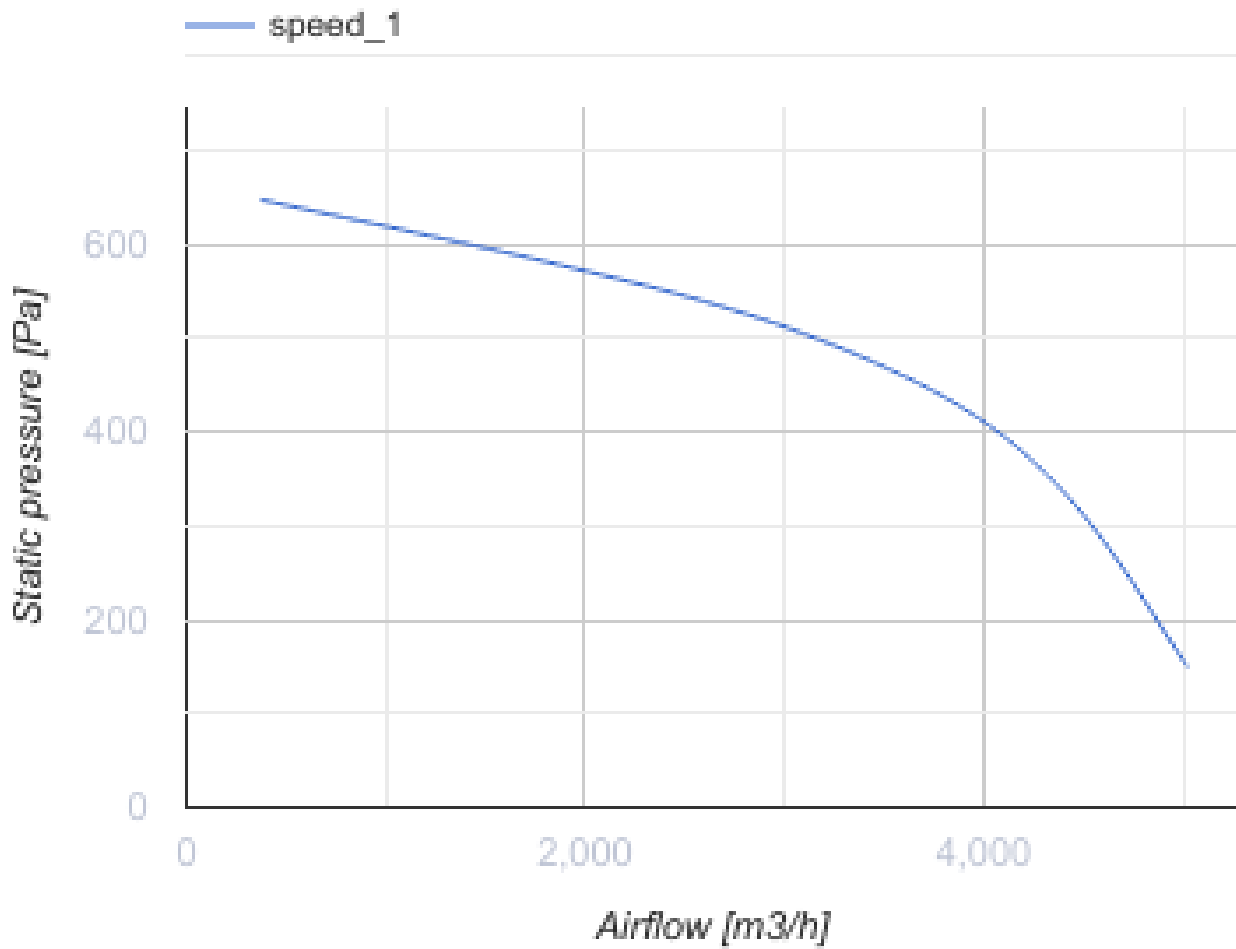

## Dimensions

<b>B</b>	<b>B1</b>	<b>B2</b>	<b>B3</b>	<b>H</b>	<b>H1</b>	<b>H2</b>	<b>H3</b>	<b>L</b>
600	620	640	670	350	370	390	530	735



## Ecodesign

Trademark	Vents
Model	VKPFI 4D 600x350
Type of drive installed	External MSD or VSD
Type of heat recovery system	None
Nominal flow rate (m <sup>3</sup> /s)	0.748
Nominal external pressure (Pa)	542
Maximum external leakage rates (%)	2.7
Static efficiency (%)	36.9
Declared typology	NRVU UVU
Sound power level (dB(A))	72
Effective electric power input (kW)	1.12