

VKVz 280 EC

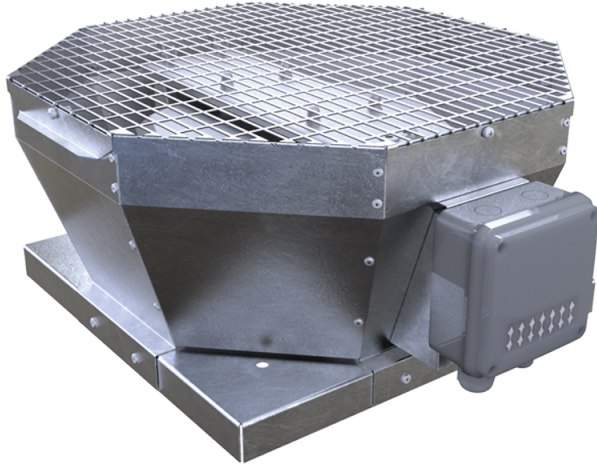

Roof exhaust centrifugal fans with vertical air exhaust

- Maximum airflow: 2330
- Sound pressure level LpA at 3 m: 48
- Motor type: EC
- Impeller type: Centrifugal backward curved blades
- Casing material: Galvanized steel

	Unit of measurement	VKVz 280 EC
Speed	-	1
Minimum supply voltage	V	230
Maximum supply voltage	V	230
Power supply frequency	Hz	50/60
Rated power	W	182
Unit current	A	1.34
Maximum airflow	m ³ /h	2330
Sound pressure level LpA at 3 m	dB(A)	48
Weight	kg	13
Transported air temperature (max)	°C	60
Transported air temperature (min)	°C	-20
Ingress protection rating	-	IPX4
Ingress protection rating of the drive	-	IP44

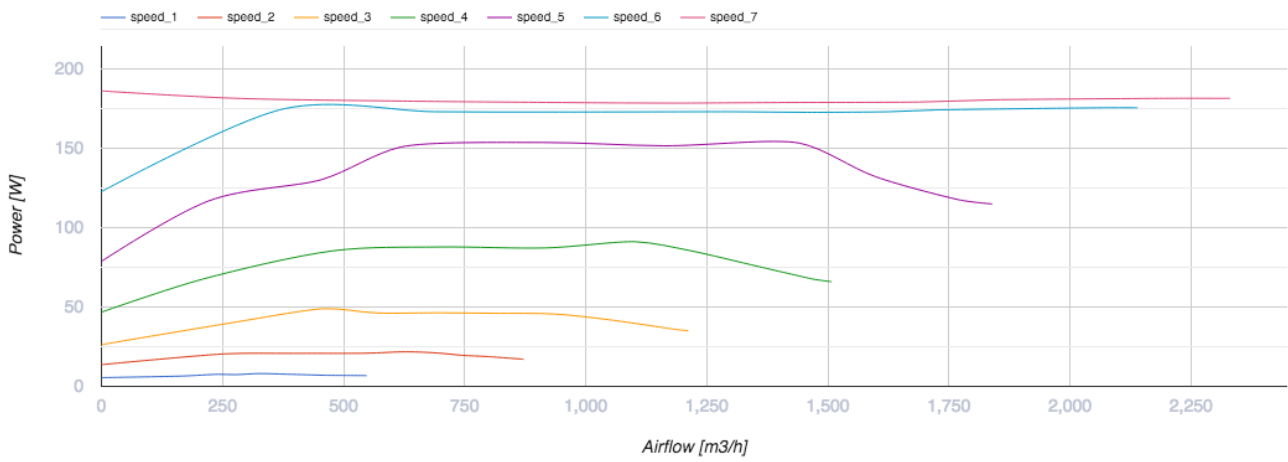
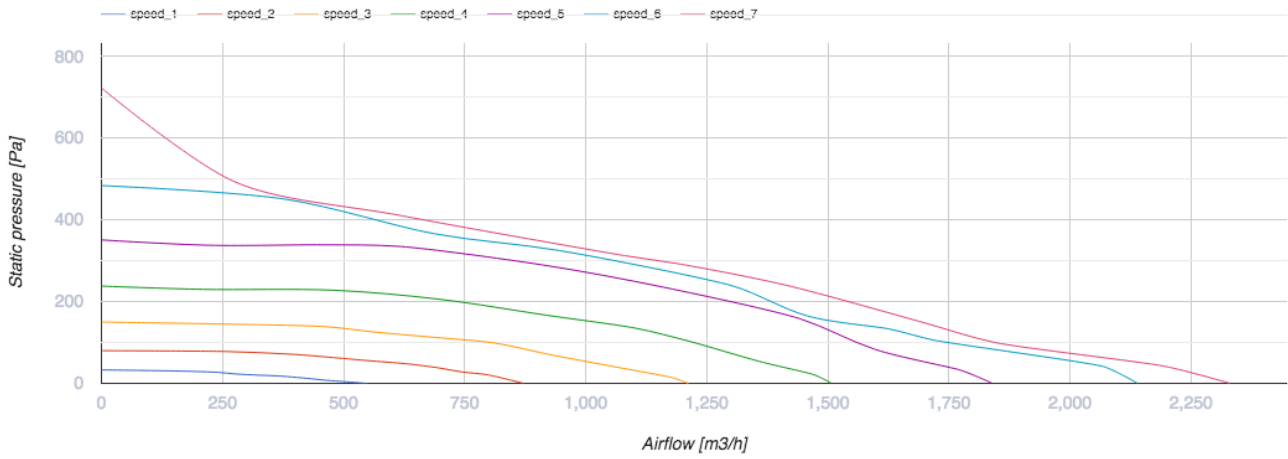

Dimensions

A	B	C
547	425	274



Ecodesign

Trademark	Vents
Model	VKVz 280 EC
Type of drive installed	Integrated VSD
Type of heat recovery system	None
Nominal flow rate (m ³ /s)	0.331
Nominal external pressure (Pa)	293
Maximum external leakage rates (%)	2.7
Static efficiency (%)	63.1
Declared typology	NRVU UVU
Effective electric power input (kW)	0.179
Sound power level (dB(A))	68