

# VPA 150-6,0-3 LCD



Supply units in the compact sound- and heat-insulated casing with electric heater

- Power of electrical reheater: 6000
- Maximum airflow: 425
- Sound pressure level LpA at 3 m: 29
- Filter: G4
- Sound insulation
- Motor type: AC
- Reheater: Electric
- Control: Remote Control
- Casing material: Galvanized steel

	Unit of measurement	VPA 150-6,0-3 LCD
Connected air duct size	mm	150
Speed	-	1
Minimum supply voltage	V	400
Maximum supply voltage	V	400
Power supply frequency	Hz	50
Rated power	W	98
Power of electrical reheater	W	6000
Unit current	A	8.7
Maximum airflow	m <sup>3</sup> /h	425
Sound pressure level LpA at 3 m	dB(A)	29
Weight	kg	52
Filter	-	G4
Transported air temperature (max)	°C	55
Transported air temperature (min)	°C	-25
Ambient air temperature min	°C	0
Ambient air temperature max	°C	40
Ambient air humidity max	%	80
Ingress protection rating	-	IP22
Ingress protection rating of the drive	-	IP44





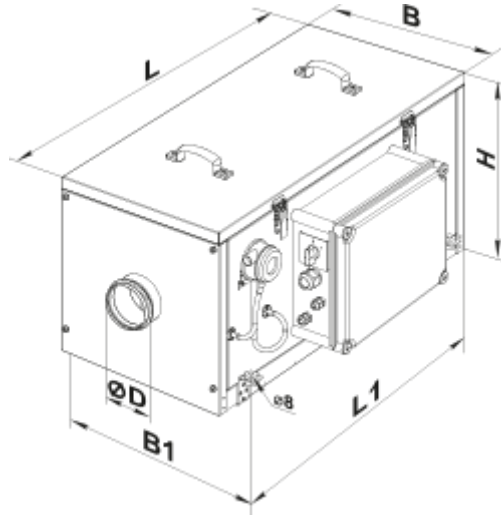

## Dimensions

ØD	B	B1	H	L	L1
149	455	496.5	438	800	647





## Accessories

### For round ducts

Name	Photo	Description
<a href="#">SR 150/600</a>		Silencer is applied for noise absorption produced during the ventilating equipment operation and spread along the ducting systems
<a href="#">SR 150/900</a>		Silencer is applied for noise absorption produced during the ventilating equipment operation and spread along the ducting systems
<a href="#">SR 150/1200</a>		Silencer is applied for noise absorption produced during the ventilating equipment operation and spread along the ducting systems
<a href="#">SRF 150/600</a>		Silencer is applied for noise absorption produced during the ventilating equipment operation and spread along the ducting systems
<a href="#">SRF 150/900</a>		Silencer is applied for noise absorption produced during the ventilating equipment operation and spread along the ducting systems
<a href="#">SRF 150/2000</a>		Silencer is applied for noise absorption produced during the ventilating equipment operation and spread along the ducting systems

### For round ducts

Name	Photo	Description
------	-------	-------------

<a href="#">KOM 150</a>		Spring-loaded backdraft damper for round ducts
<a href="#">KRV 150</a>		Air damper for air flow cut-off in round air ducts

**Other accessories**

Name	Photo	Description
<a href="#">VVG 150</a>		Flexible anti-vibration connector

**Other accessories**

Name	Photo	Description
SF 397x364x70 G4		Panel filter G4