

# VPA 200-6,0-3 LCD



Supply units in the compact sound- and heat-insulated casing with electric heater

- Power of electrical reheater: 6000
- Maximum airflow: 810
- Sound pressure level LpA at 3 m: 30
- Filter: G4
- Sound insulation
- Motor type: AC
- Reheater: Electric
- Control: Remote Control
- Casing material: Galvanized steel

|  | Unit of measurement | VPA 200-6,0-3 LCD |
|--|---------------------|-------------------|
| Connected air duct size                | mm                  | 200               |
| Speed                                  | -                   | 1                 |
| Minimum supply voltage                 | V                   | 400               |
| Maximum supply voltage                 | V                   | 400               |
| Power supply frequency                 | Hz                  | 50                |
| Rated power                            | W                   | 193               |
| Power of electrical reheater           | W                   | 6000              |
| Unit current                           | A                   | 8.7               |
| Maximum airflow                        | m <sup>3</sup> /h   | 810               |
| Sound pressure level LpA at 3 m        | dB(A)               | 30                |
| Weight                                 | kg                  | 52                |
| Filter                                 | -                   | G4                |
| Transported air temperature (max)      | °C                  | 55                |
| Transported air temperature (min)      | °C                  | -25               |
| Ambient air temperature min            | °C                  | 0                 |
| Ambient air temperature max            | °C                  | 40                |
| Ambient air humidity max               | %                   | 80                |
| Ingress protection rating              | -                   | IP22              |
| Ingress protection rating of the drive | -                   | IP44              |





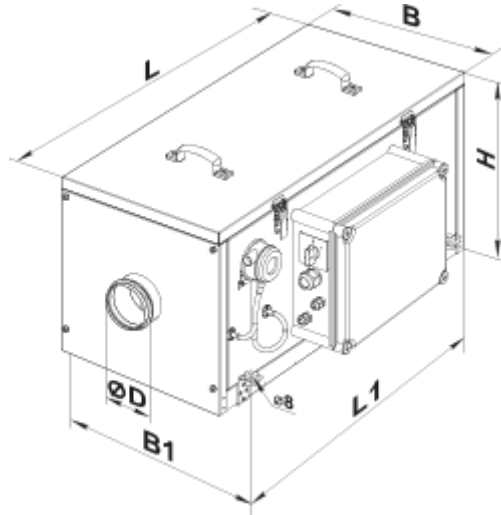

## Dimensions

| ØD  | B   | B1    | H   | L   | L1  |
|-----|-----|-------|-----|-----|-----|
| 199 | 487 | 526.5 | 513 | 835 | 684 |





## Accessories

### For round ducts

| Name                         | Photo   | Description   |
|------------------------------|---|---|
| <a href="#">SR 200/600</a>   |  | Silencer is applied for noise absorption produced during the ventilating equipment operation and spread along the ducting systems |
| <a href="#">SR 200/900</a>   |  | Silencer is applied for noise absorption produced during the ventilating equipment operation and spread along the ducting systems |
| <a href="#">SR 200/1200</a>  |  | Silencer is applied for noise absorption produced during the ventilating equipment operation and spread along the ducting systems |
| <a href="#">SRF 200/600</a>  |  | Silencer is applied for noise absorption produced during the ventilating equipment operation and spread along the ducting systems |
| <a href="#">SRF 200/900</a>  |  | Silencer is applied for noise absorption produced during the ventilating equipment operation and spread along the ducting systems |
| <a href="#">SRF 200/2000</a> |  | Silencer is applied for noise absorption produced during the ventilating equipment operation and spread along the ducting systems |

### For round ducts

| Name | Photo | Description |
|------|-------|-------------|
|------|-------|-------------|

|                         |   |  |
|-------------------------|---|--|
| <a href="#">KOM 200</a> |  | Spring-loaded backdraft damper for round ducts     |
| <a href="#">KRV 200</a> |  | Air damper for air flow cut-off in round air ducts |

**Other accessories**

| Name                    | Photo   | Description                       |
|-------------------------|---|-----------------------------------|
| <a href="#">VVG 200</a> |  | Flexible anti-vibration connector |

**Other accessories**

| Name             | Photo   | Description     |
|------------------|---|-----------------|
| SF 439x428x70 G4 |  | Panel filter G4 |