

VPA 250-3,6-3 LCD



Supply units in the compact sound- and heat-insulated casing with electric heater

- Power of electrical reheater: 3600
- Maximum airflow: 990
- Sound pressure level LpA at 3 m: 30
- Filter: G4
- Sound insulation
- Motor type: AC
- Reheater: Electric
- Control: Remote Control
- Casing material: Galvanized steel

	Unit of measurement	VPA 250-3,6-3 LCD
Connected air duct size	mm	250
Speed	-	1
Minimum supply voltage	V	400
Maximum supply voltage	V	400
Power supply frequency	Hz	50
Rated power	W	194
Power of electrical reheater	W	3600
Unit current	A	5.3
Maximum airflow	m ³ /h	990
Sound pressure level LpA at 3 m	dB(A)	30
Weight	kg	55
Filter	-	G4
Transported air temperature (max)	°C	55
Transported air temperature (min)	°C	-25
Ambient air temperature min	°C	0
Ambient air temperature max	°C	40
Ambient air humidity max	%	80
Ingress protection rating	-	IP22
Ingress protection rating of the drive	-	IP44





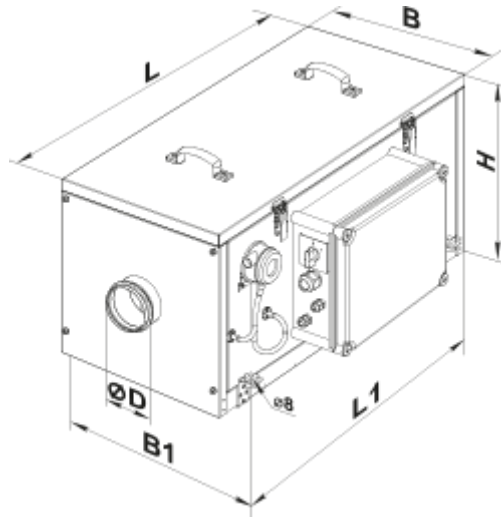

Dimensions

ØD	B	B1	H	L	L1
249	487	526.5	513	835	684





Accessories

For round ducts

Name	Photo	Description
SR 250/600		Silencer is applied for noise absorption produced during the ventilating equipment operation and spread along the ducting systems
SR 250/900		Silencer is applied for noise absorption produced during the ventilating equipment operation and spread along the ducting systems
SR 250/1200		Silencer is applied for noise absorption produced during the ventilating equipment operation and spread along the ducting systems
SRF 250/600		Silencer is applied for noise absorption produced during the ventilating equipment operation and spread along the ducting systems
SRF 250/900		Silencer is applied for noise absorption produced during the ventilating equipment operation and spread along the ducting systems
SRF 250/2000		Silencer is applied for noise absorption produced during the ventilating equipment operation and spread along the ducting systems

For round ducts

Name	Photo	Description
------	-------	-------------

KOM 250		Spring-loaded backdraft damper for round ducts
KRV 250		Air damper for air flow cut-off in round air ducts

Other accessories

Name	Photo	Description
VVG 250		Flexible anti-vibration connector

Other accessories

Name	Photo	Description
SF 439x428x70 G4		Panel filter G4