

VSK 630 D EC



Centrifugal kitchen fans in sound-insulated casing

- Maximum airflow: 14000
- Sound pressure level LpA at 3 m: 65
- Fire resistance class: 120°C within 60 min
- Sound insulation
- Motor type: EC
- Impeller type: Centrifugal impeller with backward curved blades
- Casing material: Aluzinc
- Installation in any position

	Unit of measurement	VSK 630 D EC
Connected air duct size	mm	630
Speed	-	1
Phases	-	3
Minimum supply voltage	V	400
Maximum supply voltage	V	400
Power supply frequency	Hz	50/60
Rated power	W	3000
Unit current	A	7.2
Maximum airflow	m ³ /h	14000
rotation speed at 50hz	-	1000
Sound pressure level LpA at 3 m	dB(A)	65
Weight	kg	164.5
Transported air temperature (max)	°C	120
Transported air temperature (min)	°C	-25
Ingress protection rating	-	IPX4

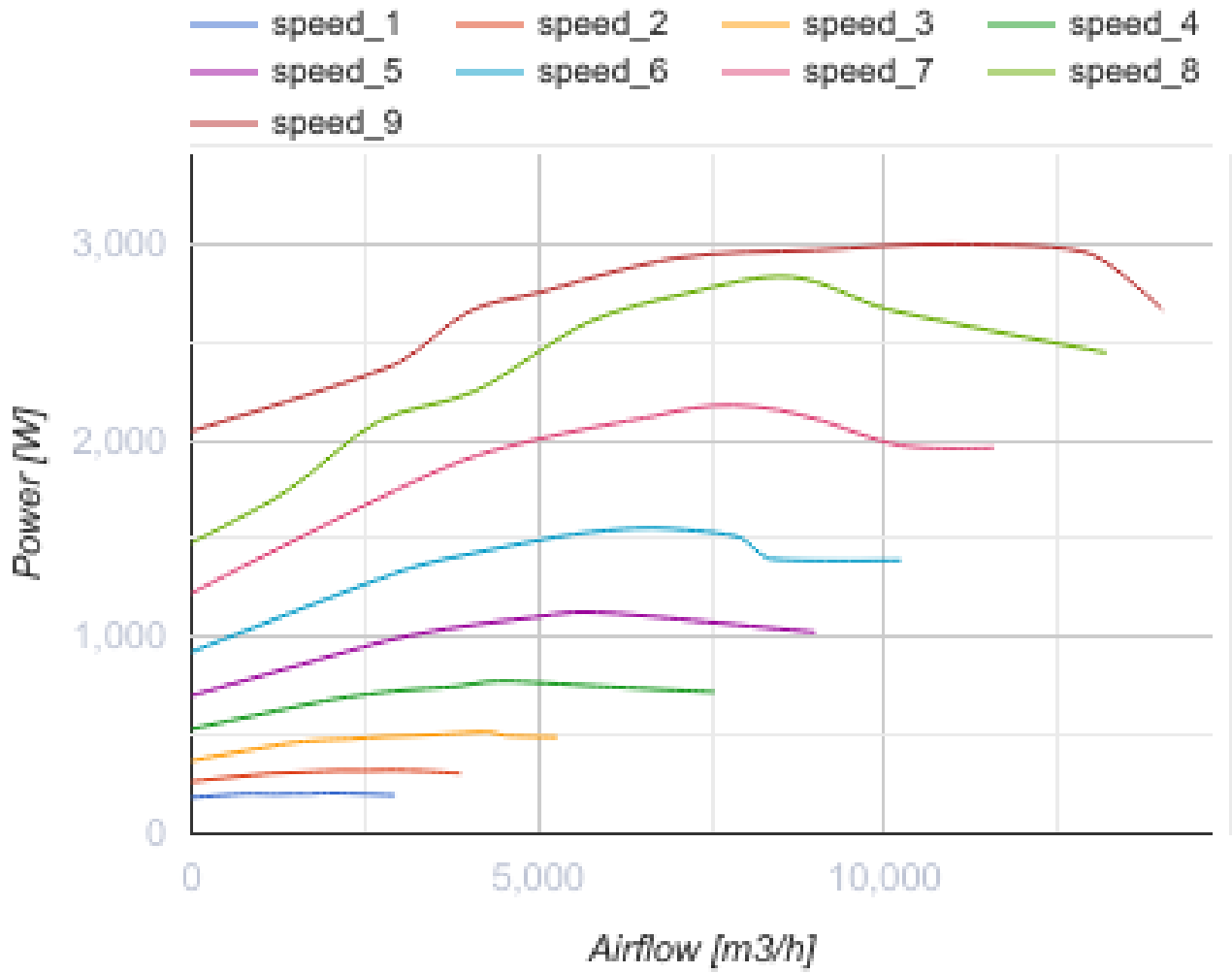

Dimensions

L	L1	H	H1	B	B1	A	C
1000	1038	1000	1038	1000	1038	409	940

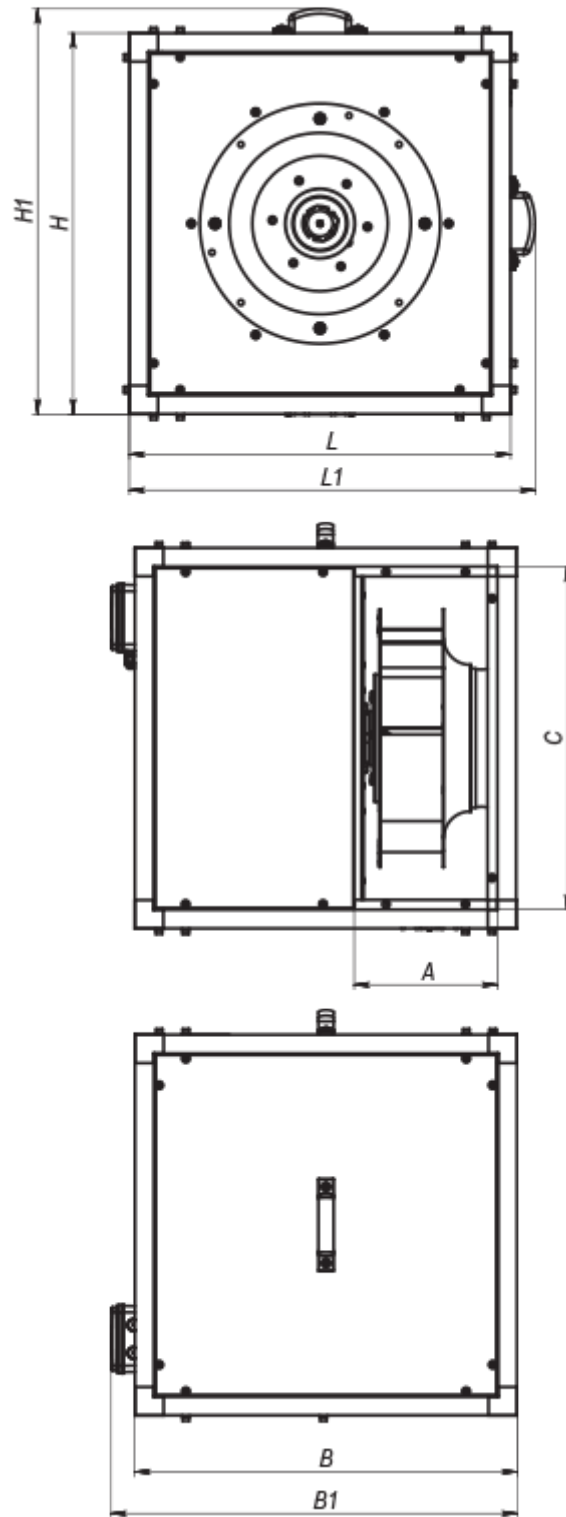

Accessories

Speed controllers

Name	Photo	Description
------	-------	-------------

[R-1/010](#)



Speed controller for EC motors