

VUT 250 PB EC L A14

Air handling units in heat- and sound-insulated casing



- Maximum airflow: 270
- Sound pressure level LpA at 3 m: 28
- Heat exchanger type: Counter flow
- Extract filter: G4
- Supply filter: F7
- Sound insulation
- Motor type: EC
- Bypass: Manual
- Control: Remote Control
- Casing material: Galvanized steel
- Humidity sensor: Optional
- CO2 sensor: Optional
- VOC sensor: Optional
- PM2.5 sensor: Optional

	Unit of measurement	VUT 250 PB EC L A14
Connected air duct size	mm	125
Speed	-	1
Minimum supply voltage	V	230
Maximum supply voltage	V	230
Power supply frequency	Hz	50/60
Rated power	W	101
Unit current	A	0.8
Maximum airflow	m ³ /h	270
Sound pressure level LpA at 3 m	dB(A)	28
Heat recovery efficiency, max	%	98
Heat exchanger type	-	Counter flow
Heat exchanger material	-	Polystyrene
Weight	kg	48
Extract filter	-	G4
Supply filter	-	F7
Transported air temperature (max)	°C	40
Transported air temperature (min)	°C	-25
Ambient air temperature min	°C	1
Ambient air temperature max	°C	40
Ambient air humidity max	%	80
Ingress protection rating	-	IP22



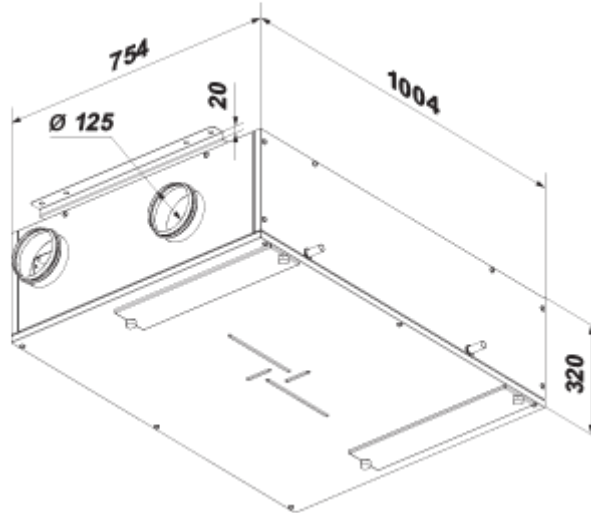

Ingress protection rating of the drive	-	IP44
--	---	------

Dimensions



Accessories

Sensors

Name	Photo	Description
HV2		Humidity sensor
CO2-1		CO2 sensors
CO2-2		CO2 sensors
HR-S		Electro-mechanical humidistats

Condensation drainage

Name	Photo	Description
SH-32		The hydraulic U-trap for condensate drainage from heat exchangers and coolers in ventilation and air conditioning systems

For round ducts



Name	Photo	Description
------	-------	-------------

KRV 125		Air damper for air flow cut-off in round air ducts
-------------------------	---	--

Electric actuators

Name	Photo	Description
Belimo LF230		The Belimo LF series actuators are designed for controlling air dampers with cross section up to 0.8 m ² performing protection functions

Other accessories

Name	Photo	Description
SF 403x253x48 G4		Panel filter G4
SF 403x253x48 F7		F7 panel filter