

VUT 3000 PBE EC A21 DTV



Ceiling mounted air handling units in compact heat- and sound-insulated casing with an electric heater

- Power of electrical reheater: 21000
- Maximum airflow: 4300
- Sound pressure level LpA at 3 m: 46
- Heat exchanger type: Cross flow
- Extract filter: G4
- Supply filter: G4
- Sound insulation
- Motor type: EC
- Bypass: Auto
- Reheater: Electric
- BMS protocol: ModBus
- Control: Smartphone
- Casing material: Galvanized steel
- Humidity sensor: Optional
- CO2 sensor: Optional
- VOC sensor: Optional
- PM2.5 sensor: Optional

	Unit of measurement	VUT 3000 PBE EC A21 DTV
Connected air duct size	mm	400
Speed	-	1
Phases	-	3
Minimum supply voltage	V	400
Maximum supply voltage	V	400
Power supply frequency	Hz	50/60
Rated power	W	2226
Power of electrical reheater	W	21000
Unit current	A	33.5
Maximum airflow	m ³ /h	4300
Sound pressure level LpA at 3 m	dB(A)	46
Heat recovery efficiency, max	%	72
Heat exchanger type	-	Cross flow
Heat exchanger material	-	Aluminum
Weight	kg	281
Extract filter	-	G4
Supply filter	-	G4
Transported air temperature (max)	°C	40
Transported air temperature (min)	°C	-25

Ambient air temperature min	°C	1
Ambient air temperature max	°C	40
Ambient air humidity max	%	60
Ingress protection rating	-	IP22
Ingress protection rating of the drive	-	IP44

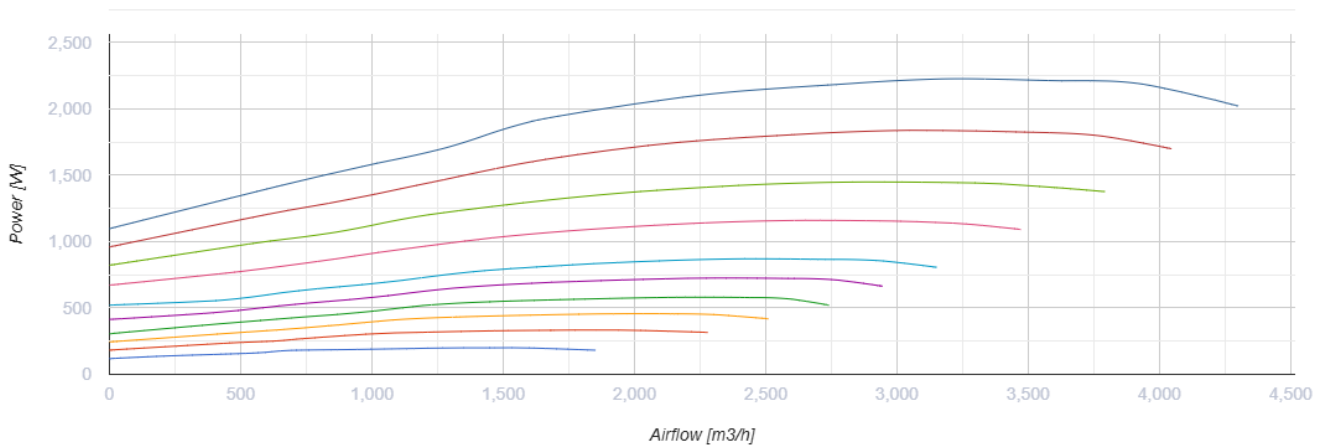
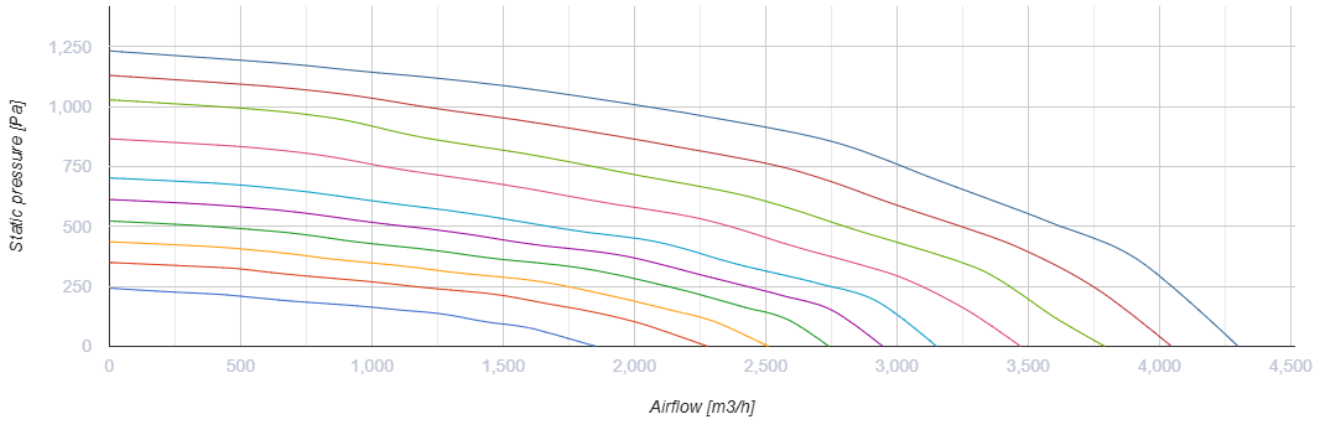

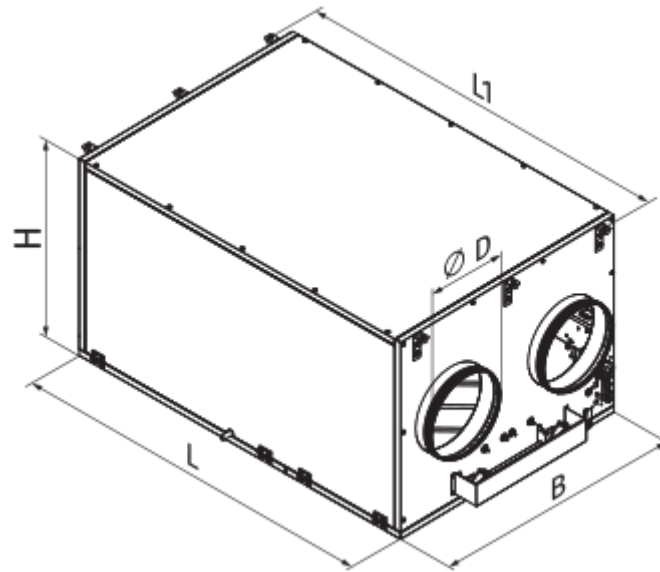

Dimensions

ØD	B	H	L	L1
400	1265	881	1835	1888







Accessories

Control Panels for AHU



Name	Photo	Description
A22		The A22/A22 WiFi control panels are used for control of industrial and domestic air handling units with an A21 automation system.
A22 WiFi		The A22/A22 WiFi control panels are used for control of industrial and domestic air handling units with an A21 automation system.
A25		The control panel with a sensor display

Sensors

Name	Photo	Description
HV2		Humidity sensor
CO2-1		CO2 sensors
CO2-2		CO2 sensors
HR-S		Electro-mechanical humidistats

DPWC11200		Humidity sensor
---------------------------	---	-----------------



VOC sensors

Name	Photo	Description
DPWQ30600		VOC sensors
DPWQ40200		CO2 sensor

Condensation drainage

Name	Photo	Description
SH-32		The hydraulic U-trap for condensate drainage from heat exchangers and coolers in ventilation and air conditioning systems



For round ducts

Name	Photo	Description
SR 400/900		Silencer is applied for noise absorption produced during the ventilating equipment operation and spread along the ducting systems
SR 400/1200		Silencer is applied for noise absorption produced during the ventilating equipment operation and spread along the ducting systems

For round ducts

Name	Photo	Description
KRV 400		Air damper for air flow cut-off in round air ducts

Electric actuators

Name	Photo	Description
Belimo LF230		The Belimo LF series actuators are designed for controlling air dampers with cross section up to 0.8 m ² performing protection functions
Belimo TF230		The actuators are designed for controlling air dampers with cross section up to 0.4 m ² performing protection functions

Other accessories

Name	Photo	Description
SF 827x741x48 G4		Panel filter G4