

# VUTR 1500 EH EC A18



Air handling units in heat- and sound-insulated casing with an electric or a water heater

- Power of electrical reheater: 9000
- Maximum airflow: 1500
- Sound pressure level LpA at 3 m: 62
- Heat exchanger type: Rotary
- Extract filter: G4
- Supply filter: G4
- Sound insulation
- Motor type: EC
- Reheater: Electric
- Control: Remote Control
- Casing material: Galvanized steel
- Humidity sensor: Optional
- CO2 sensor: Optional
- VOC sensor: Optional
- PM2.5 sensor: Optional

	Unit of measurement	VUTR 1500 EH EC A18
Connected air duct size	mm	315
Speed	-	1
Minimum supply voltage	V	400
Maximum supply voltage	V	400
Power supply frequency	Hz	50/60
Rated power	W	750
Power of electrical reheater	W	9000
Unit current	A	14.1
Maximum airflow	m <sup>3</sup> /h	1500
Sound pressure level LpA at 3 m	dB(A)	62
Heat recovery efficiency, max	%	95
Heat exchanger type	-	Rotary
Heat exchanger material	-	Aluminum
Weight	kg	175
Extract filter	-	G4
Supply filter	-	G4
Transported air temperature (max)	°C	40
Transported air temperature (min)	°C	-25
Ambient air temperature min	°C	1

Ambient air temperature max	°C	40
Ambient air humidity max	%	80
Ingress protection rating	-	IP22
Ingress protection rating of the drive	-	IP44

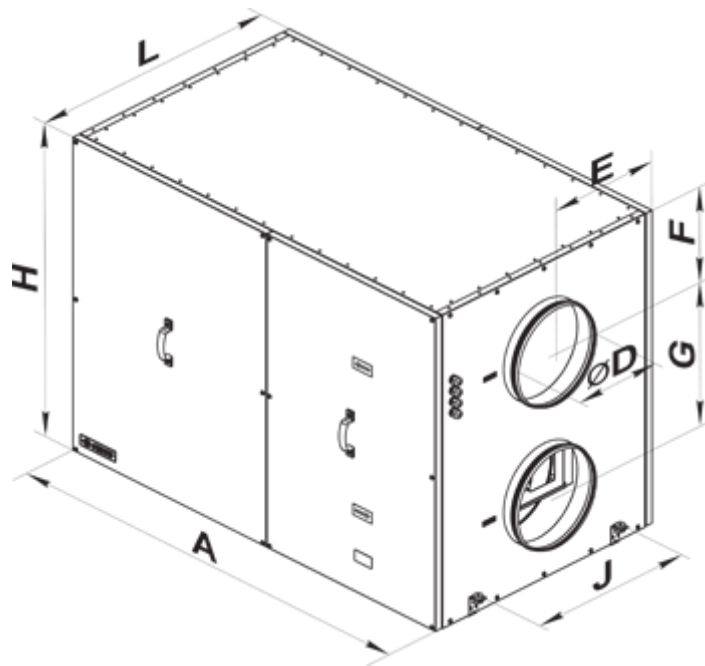

## Dimensions

ØD	A	E	F	G	J	H	L
314	1430	427	275	460	560	1010	855





## Accessories

### VOC sensors



Name	Photo	Description
<a href="#">DPWQ30600</a>		VOC sensors
<a href="#">DPWQ40200</a>		CO2 sensor

### Sensors

Name	Photo	Description
<a href="#">DPWC11200</a>		Humidity sensor

<a href="#">HR-S</a>		Electro-mechanical humidistats
<a href="#">HV2</a>		Humidity sensor



### For round ducts

Name	Photo	Description
<a href="#">KOM 315</a>		Spring-loaded backdraft damper for round ducts
<a href="#">KRV 315</a>		Air damper for air flow cut-off in round air ducts

### Electric actuators

Name	Photo	Description
<a href="#">Belimo CM230</a>		The actuators are designed for controlling air dampers with cross section up to 0.4 m <sup>2</sup>

### Other accessories

Name	Photo	Description
SFK 800x477x27 G4		G4 pocket filter
SF 800x477x47 G4		Panel filter G4
PCOS004850		The control module is designed for connection of the pCO series controllers (except for pCOB) to ventilation control systems in compliance with the Modbus RS485 protocol.