

VUTR 900 EH EC A17

Air handling units in heat- and sound-insulated casing with an electric or a water heater



- Power of electrical reheater: 4500
- Maximum airflow: 900
- Sound pressure level LpA at 3 m: 58
- Heat exchanger type: Rotary
- Extract filter: G4
- Supply filter: G4
- Sound insulation
- Motor type: EC
- Reheater: Electric
- Control: Remote Control
- Casing material: Galvanized steel
- Humidity sensor: Optional
- CO2 sensor: Optional
- VOC sensor: Optional
- PM2.5 sensor: Optional

	Unit of measurement	VUTR 900 EH EC A17
Connected air duct size	mm	250
Speed	-	1
Minimum supply voltage	V	400
Maximum supply voltage	V	400
Power supply frequency	Hz	50/60
Rated power	W	440
Power of electrical reheater	W	4500
Unit current	A	7.2
Maximum airflow	m ³ /h	900
Sound pressure level LpA at 3 m	dB(A)	58
Heat recovery efficiency, max	%	95
Heat exchanger type	-	Rotary
Heat exchanger material	-	Aluminum
Weight	kg	130
Extract filter	-	G4
Supply filter	-	G4
Transported air temperature (max)	°C	40
Transported air temperature (min)	°C	-25
Ambient air temperature min	°C	1
Ambient air temperature max	°C	40
Ambient air humidity max	%	80

Ingress protection rating	-	IP22
Ingress protection rating of the drive	-	IP44

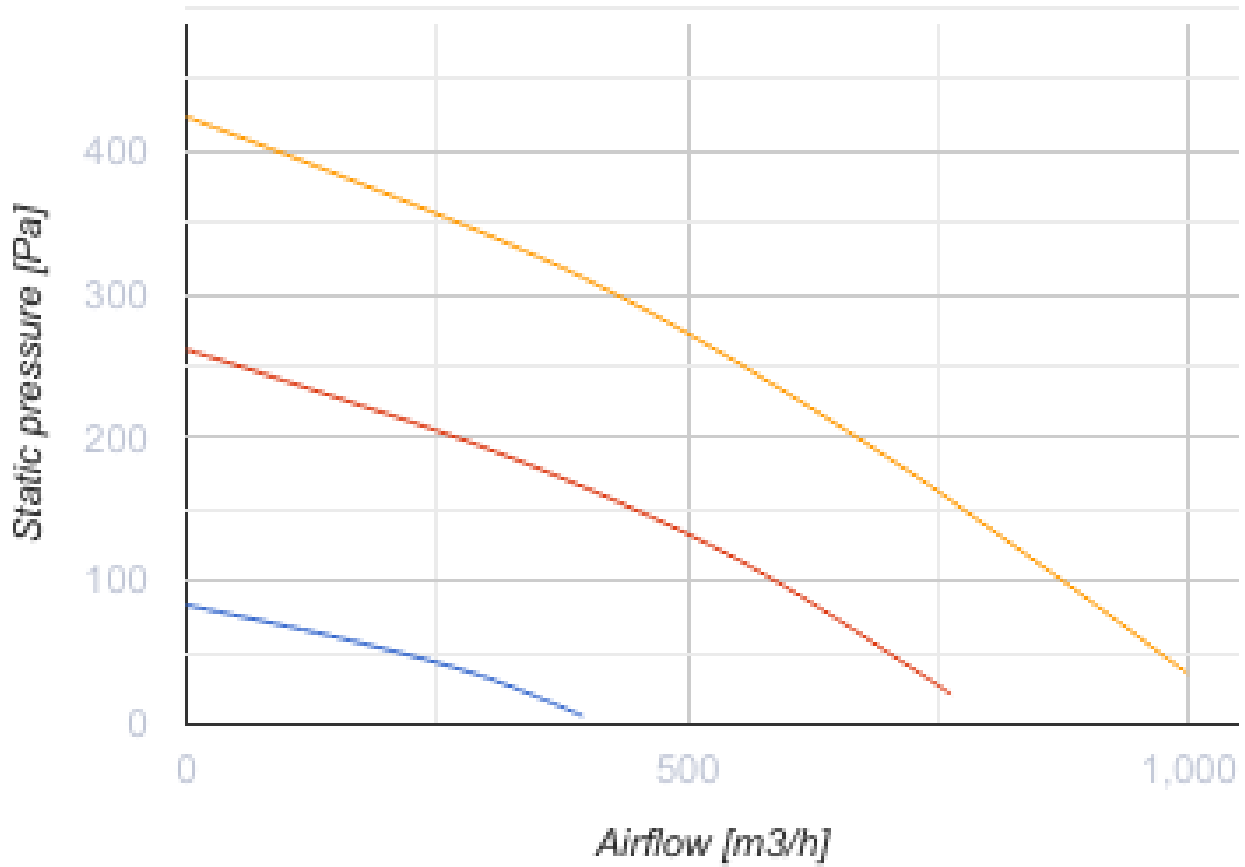

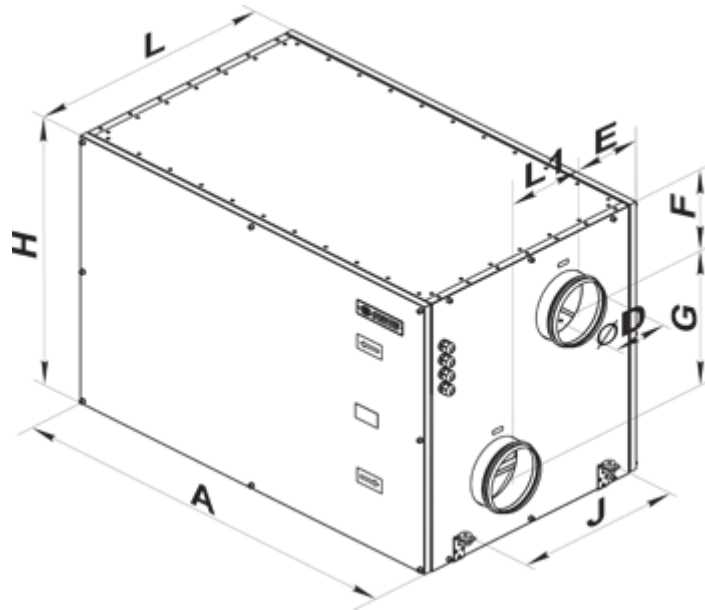

Dimensions

ØD	A	E	F	G	J	H	L	L1
249	1210	243	180	340	580	700	745	260





Accessories

VOC sensors

Name	Photo	Description
DPWQ30600		VOC sensors
DPWQ40200		CO2 sensor

Sensors

Name	Photo	Description
DPWC11200		Humidity sensor
HR-S		Electro-mechanical humidistats
HV2		Humidity sensor

For round ducts



Name	Photo	Description
KOM 250		Spring-loaded backdraft damper for round ducts

KRV 250		Air damper for air flow cut-off in round air ducts
-------------------------	---	--

Electric actuators

Name	Photo	Description
Belimo CM230		The actuators are designed for controlling air dampers with cross section up to 0.4 m ²

Other accessories

Name	Photo	Description
SFK 700x333x27 G4		G4 pocket filter
SF 700x332x48 G4		Panel filter G4
PCOS004850		The control module is designed for connection of the pCO series controllers (except for pCOB) to ventilation control systems in compliance with the Modbus RS485 protocol.