

VUTR 900 TH EH EC A17



The heat recovery air handling units in sound- and heat-insulated casings are equipped with a rotary heat exchanger and a built-in heat pump

- Power of electrical preheater: 2700
- Maximum airflow: 955
- Sound pressure level LpA at 3 m: 58
- Heat exchanger type: Rotary
- Extract filter: G4
- Supply filter: G4 (F7 option)
- Sound insulation
- Motor type: EC
- Preheater: Built-in
- Control: Remote Control
- Casing material: Galvanized steel
- Humidity sensor: Optional
- CO2 sensor: Optional
- VOC sensor: Optional
- PM2.5 sensor: Optional

	Unit of measurement	VUTR 900 TH EH EC A17
Connected air duct size	mm	250
Speed	-	1
Phases	-	1
Minimum supply voltage	V	230
Maximum supply voltage	V	230
Power supply frequency	Hz	50
Rated power	W	460
Power of electrical preheater	W	2700
Unit current	A	19.4
Maximum airflow	m ³ /h	955
Sound pressure level LpA at 3 m	dB(A)	58
Heat recovery efficiency, max	%	85
Heat exchanger type	-	Rotary
Heat exchanger material	-	Aluminum
Weight	kg	165
Extract filter	-	G4
Supply filter	-	G4 (F7 option)
Transported air temperature (max)	°C	40
Transported air temperature (min)	°C	-25

Ambient air temperature min	°C	1
Ambient air temperature max	°C	40
Ambient air humidity max	%	80
Ingress protection rating	-	IP22
Ingress protection rating of the drive	-	IP44

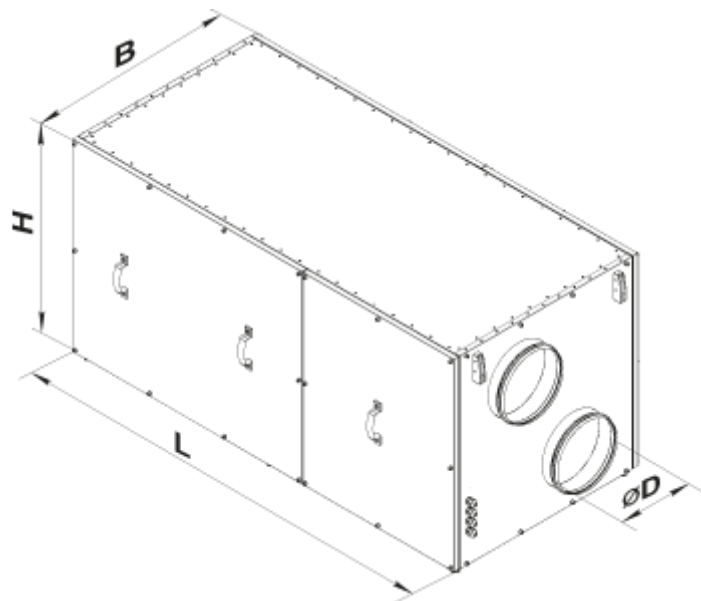

Dimensions

ØD	B	H	L
249	748	750	1667



Accessories

Sensors

Name	Photo	Description
HV2		Humidity sensor
DPWC11200		Humidity sensor

VOC sensors



Name	Photo	Description
DPWQ30600		VOC sensors

DPWQ40200		CO2 sensor
---------------------------	---	------------



For round ducts

Name	Photo	Description
KOM 250		Spring-loaded backdraft damper for round ducts
KRV 250		Air damper for air flow cut-off in round air ducts

Electric actuators

Name	Photo	Description
Belimo LF230		The Belimo LF series actuators are designed for controlling air dampers with cross section up to 0.8 m ² performing protection functions
Belimo TF230		The actuators are designed for controlling air dampers with cross section up to 0.4 m ² performing protection functions

Other accessories

Name	Photo	Description
SF 700x352x48 G4		Panel filter G4
SFK 700x351x27 G4		G4 pocket filter
SFK 700x351x27 F7		F7 pocket filter