

Bend 60°

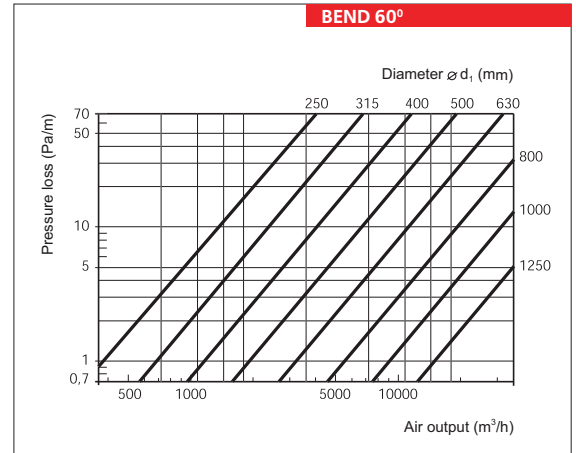
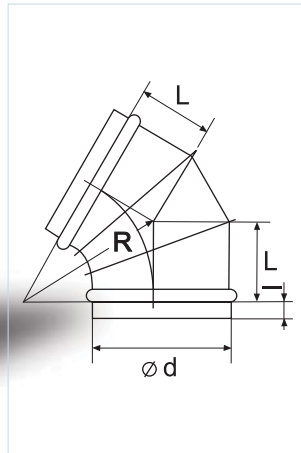

Type	Diameter (d), mm	Steel thickness (p), mm	Length (L), mm	l, mm	R, mm
Bend 60-125	125	0.50	72	50	125
Bend 60-140	140	0.50	78	50	140
Bend 60-150	150	0.50	87	50	150
Bend 60-160	160	0.50	92	50	160
Bend 60-180	180	0.50	104	50	180
Bend 60-200	200	0.50	115	50	200
Bend 60-224	224	0.50	130	50	224
Bend 60-250	250	0.50	144	50	250
Bend 60-280	280	0.50	162	50	280
Bend 60-315	315	0.50	182	50	315
Bend 60-355	355	0.50	205	60	355
Bend 60-400	400	0.70	231	60	400
Bend 60-450	450	0.70	260	60	450
Bend 60-500	500	0.70	290	80	500
Bend 60-560	560	0.70	325	80	560
Bend 60-600	600	0.70	346	80	600
Bend 60-630	630	0.70	365	80	630
Bend 60-710	710	0.70	412	80	710
Bend 60-800	800	0.70	465	80	800
Bend 60-900	900	1.00	522	100	900
Bend 60-1000	1000	1.00	580	100	1000
Bend 60-1120	1120	1.00	650	100	1120
Bend 60-1250	1250	1.00	725	100	1250